



GALAXY SQUAD

70705





LEGO.com/brickseparator

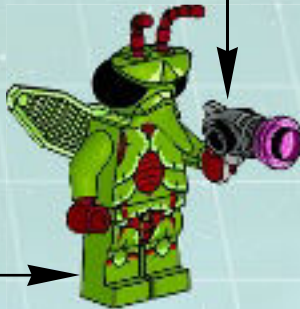
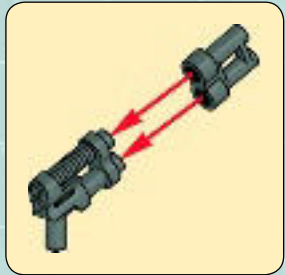
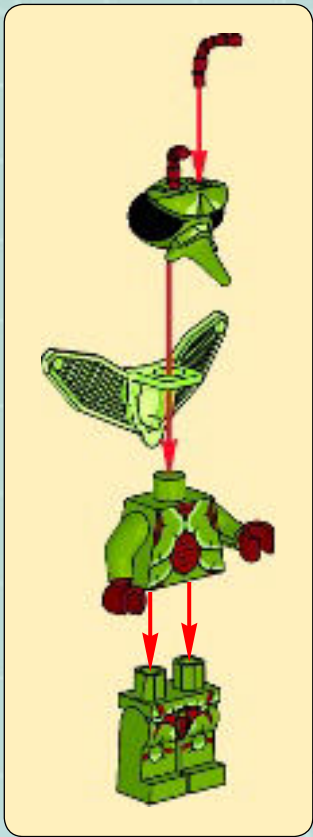
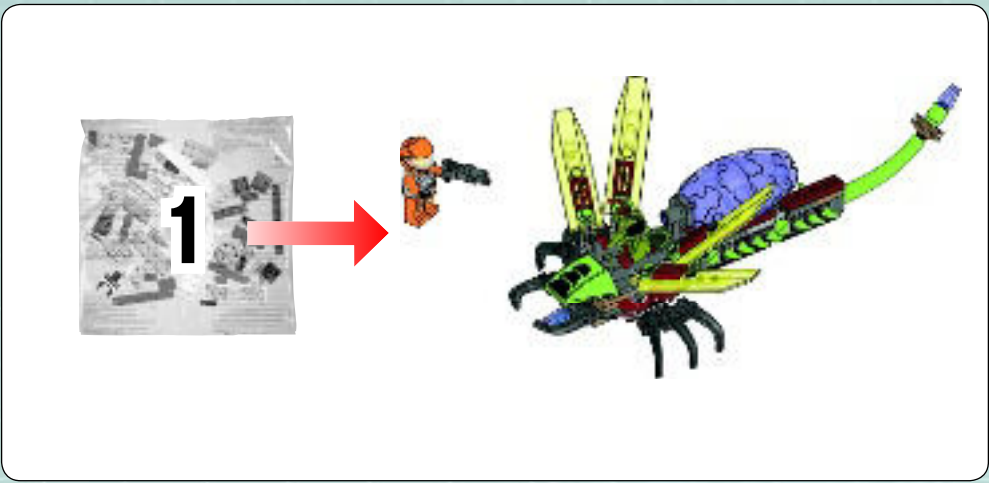

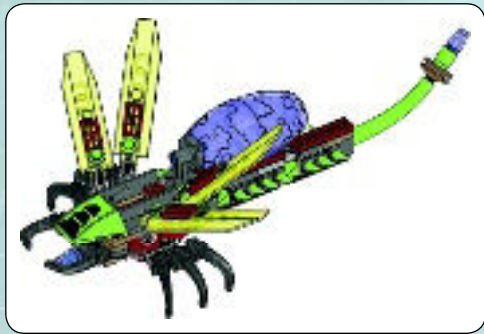

1

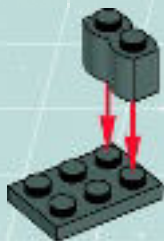

2



3

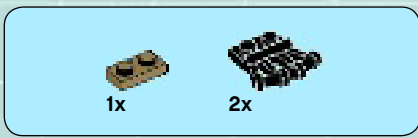

4





5

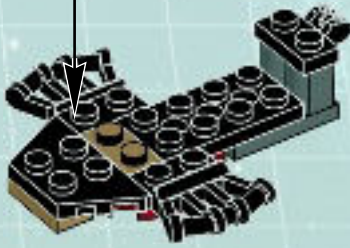
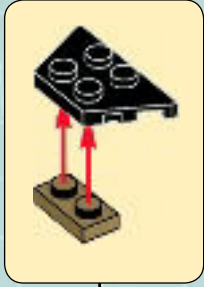

6



7

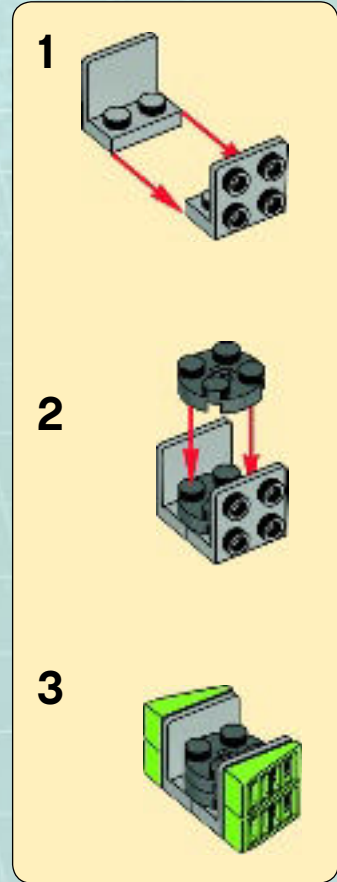

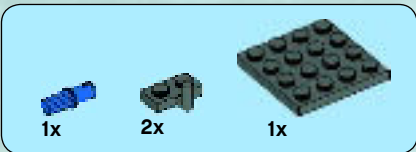

8

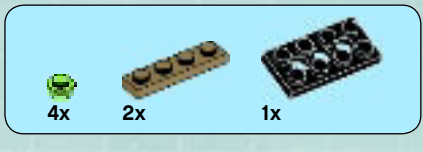

10



9

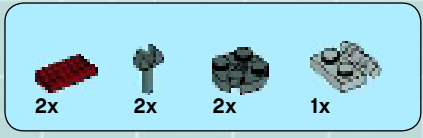

11

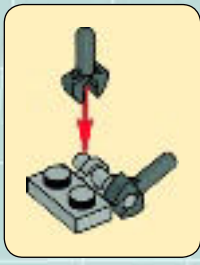
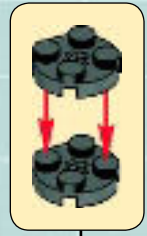

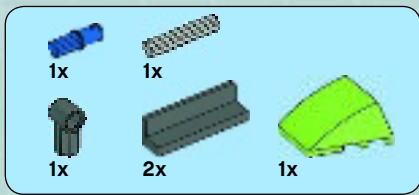

12

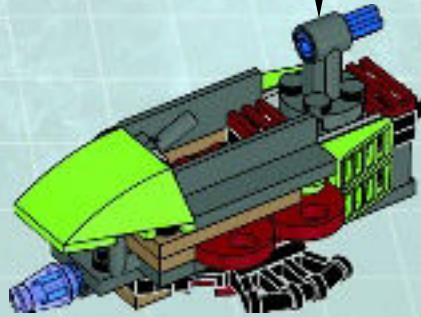
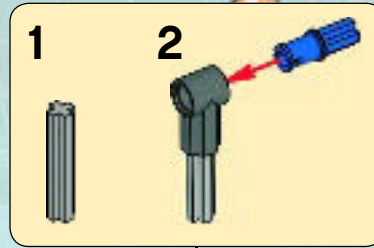

13

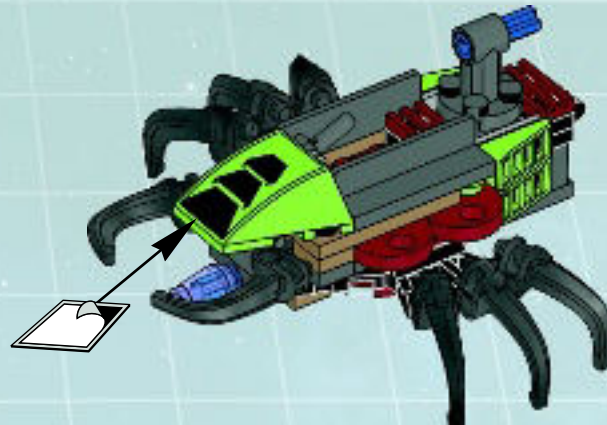

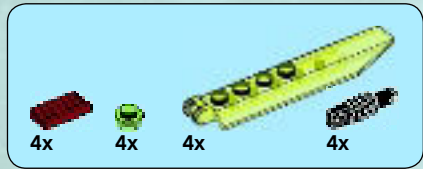

14

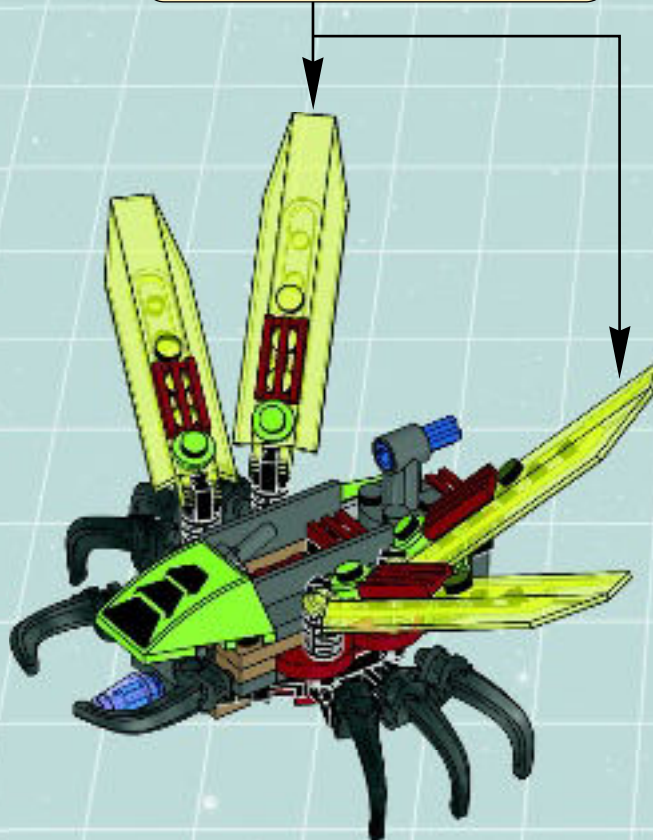
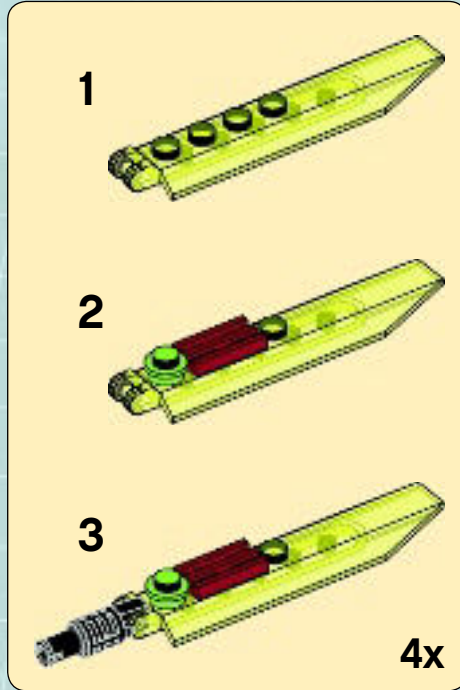

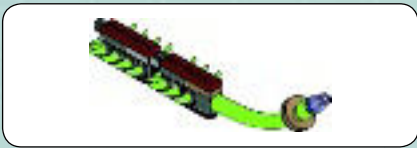

1

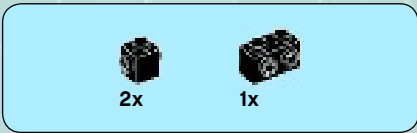

2

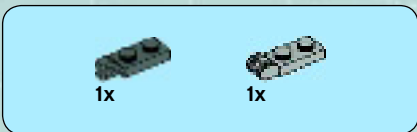
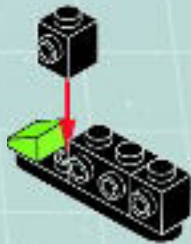

3



4

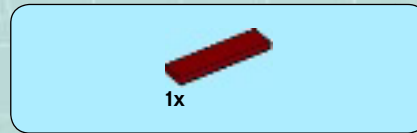

5



6

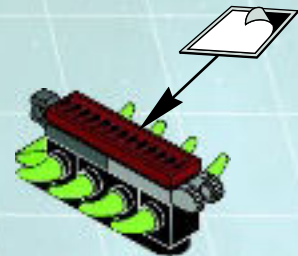

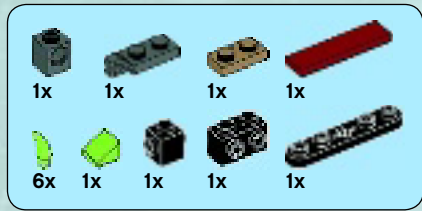

7



1



2

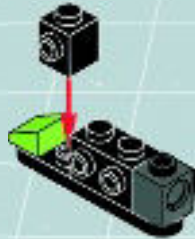

3



4



5



6

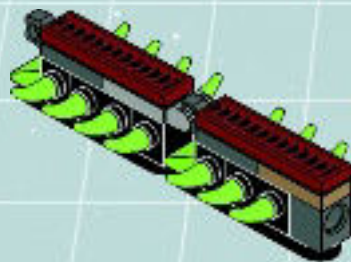
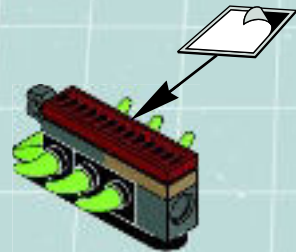



8

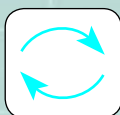
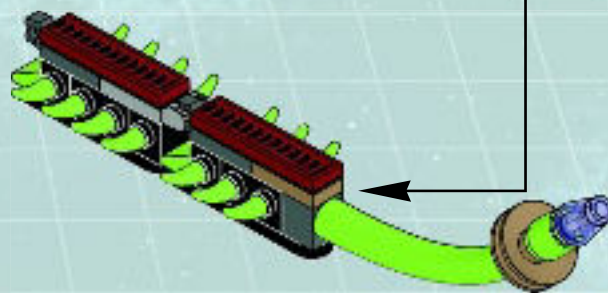
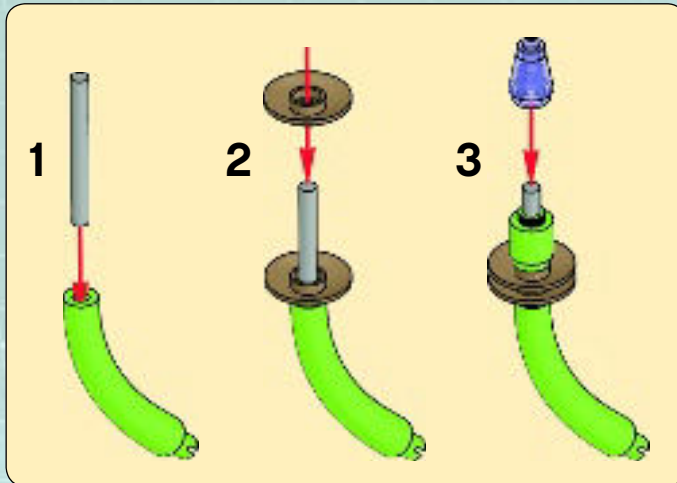

15

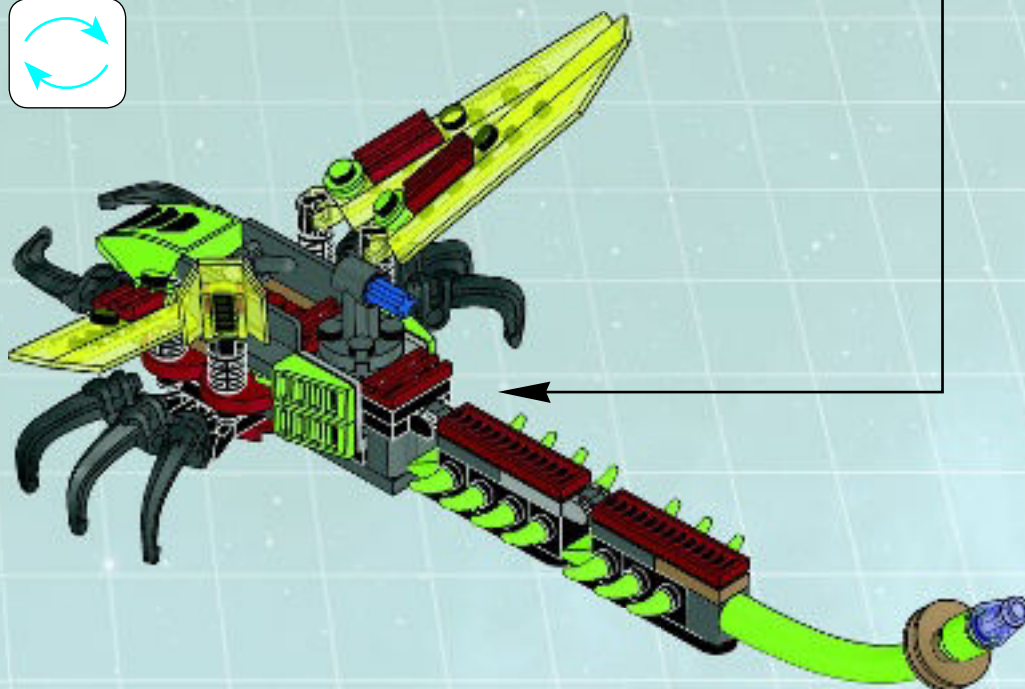



16

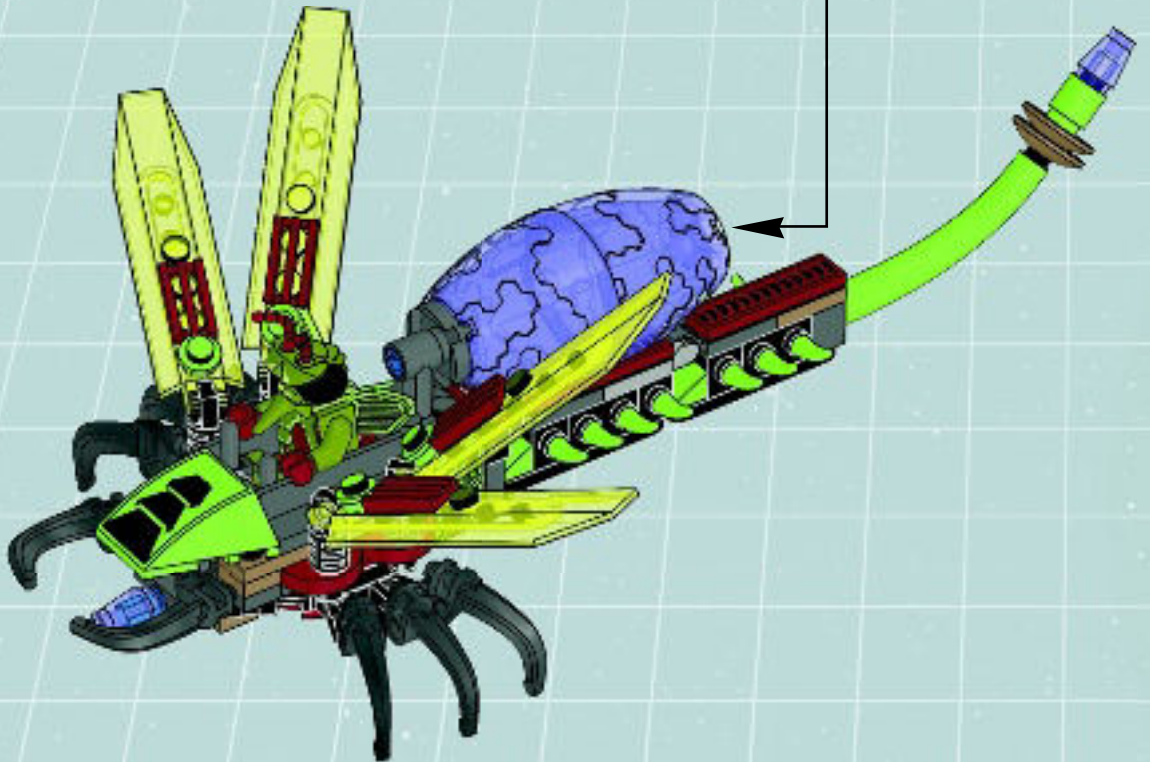
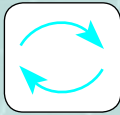
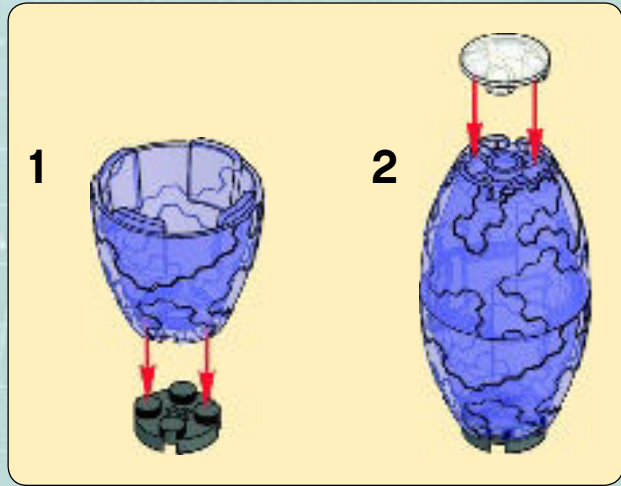

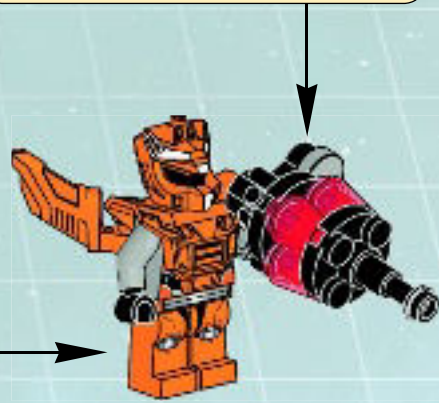
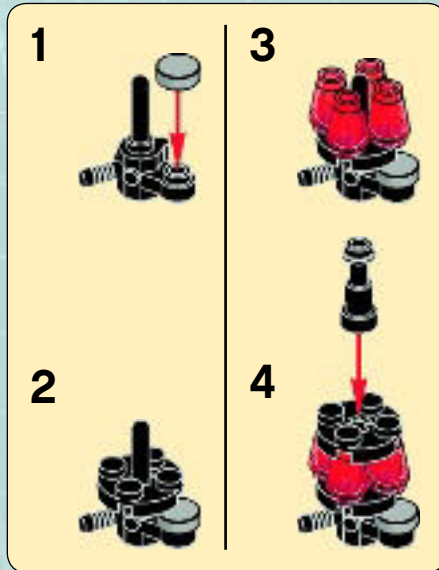
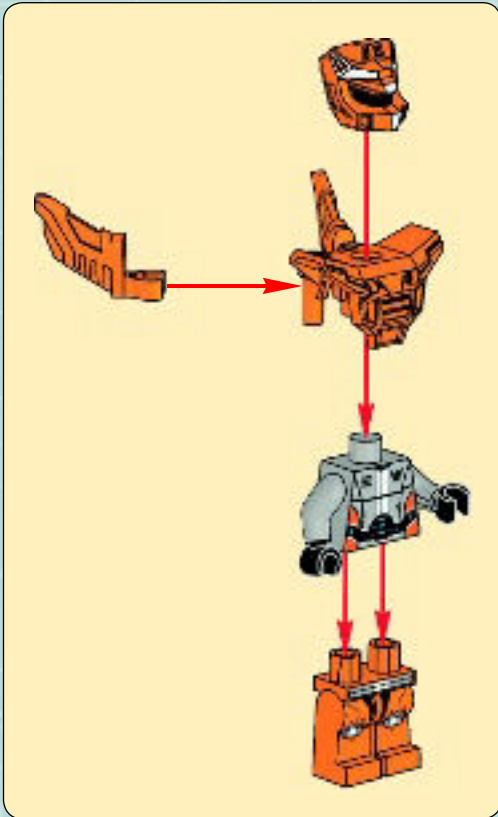
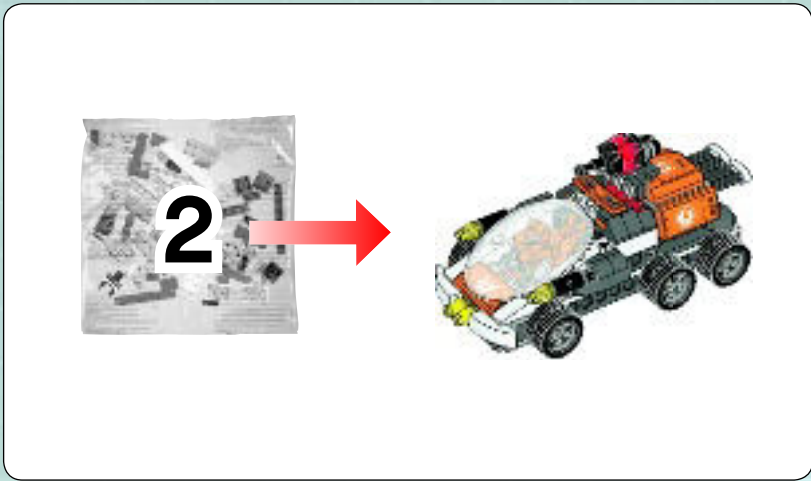

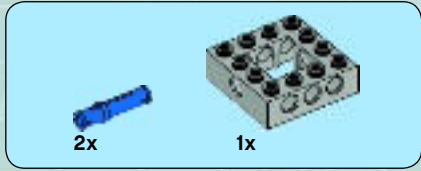

1

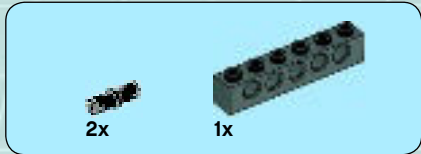
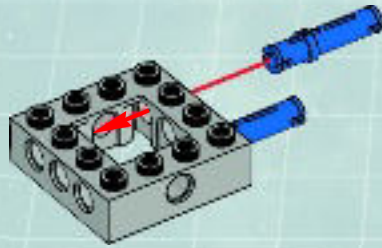

2

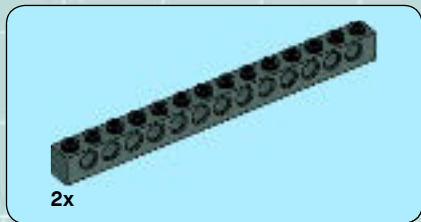
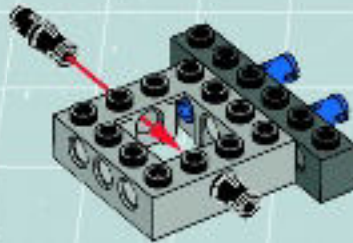

3

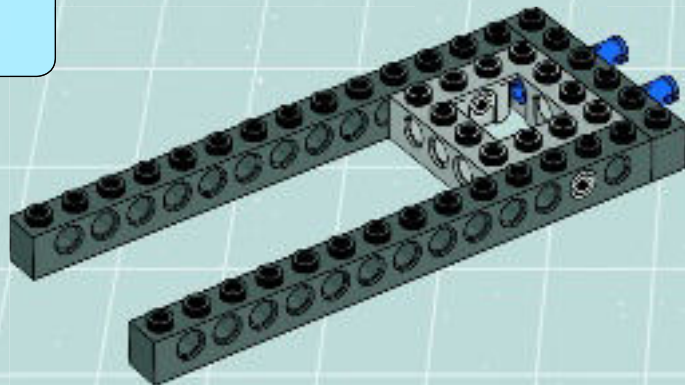

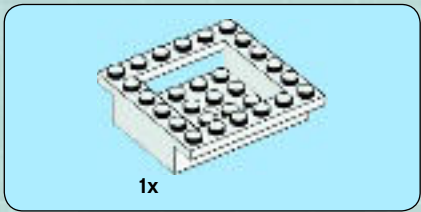

4

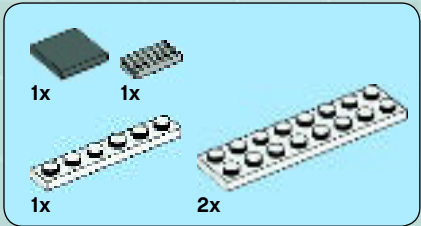
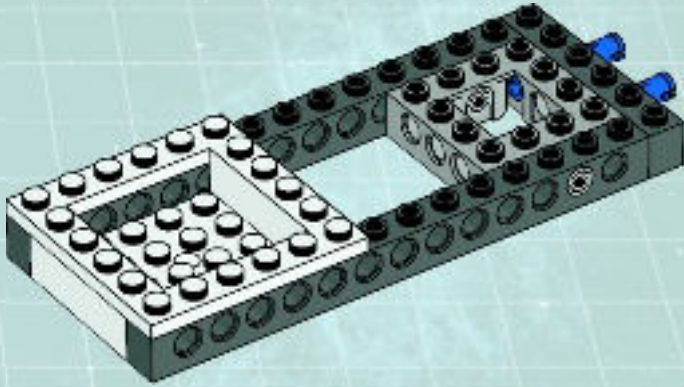

5

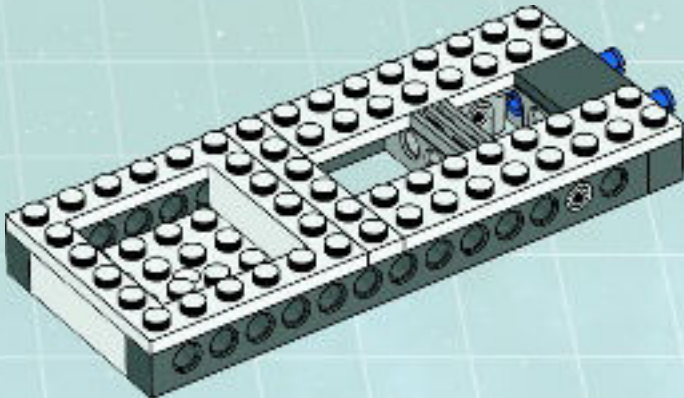

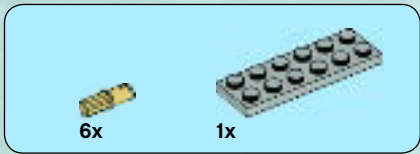

6

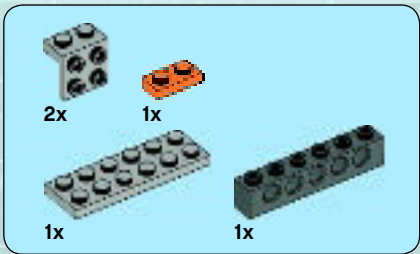
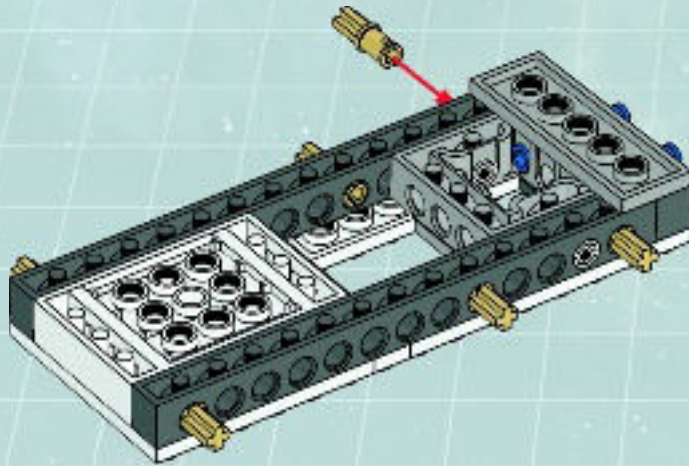

7

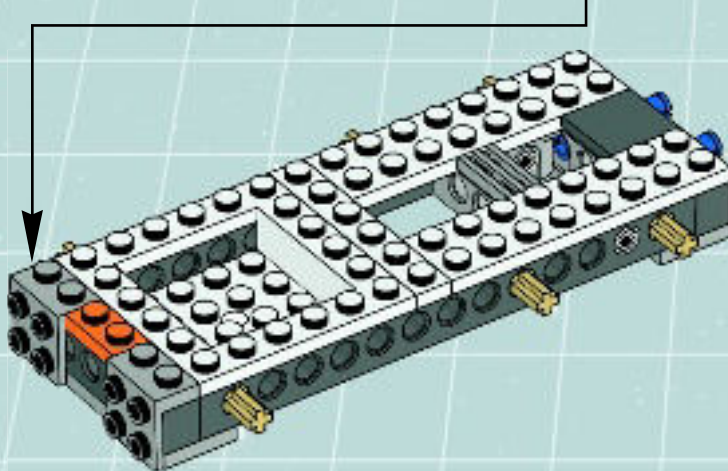
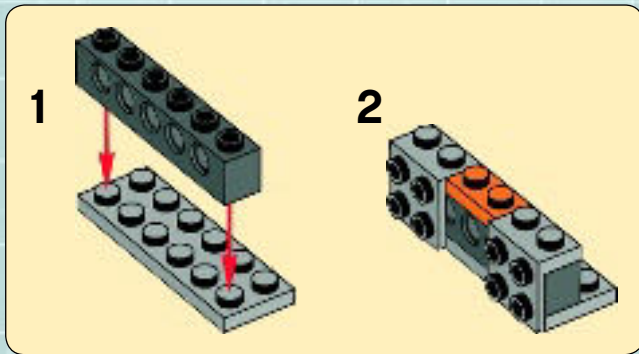

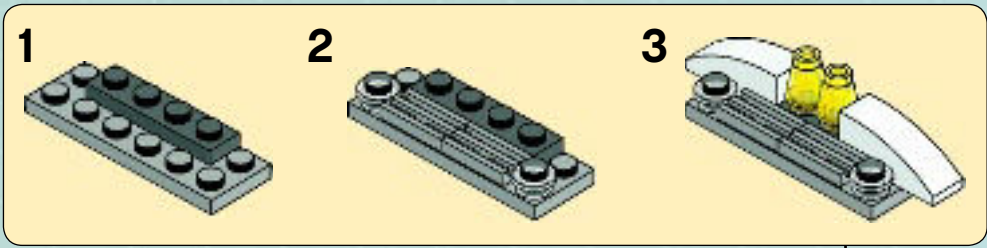
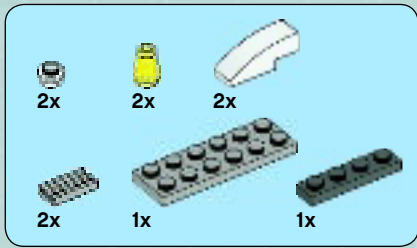

8

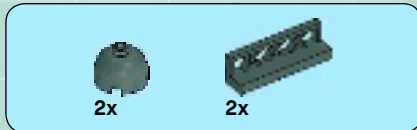
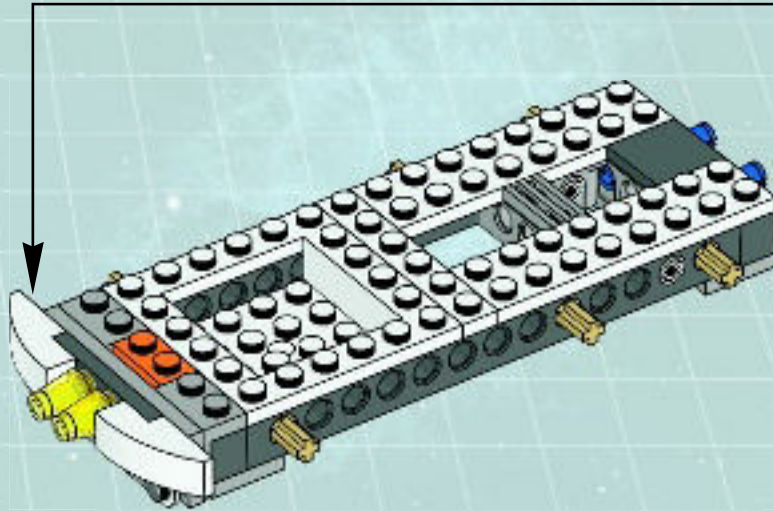

9

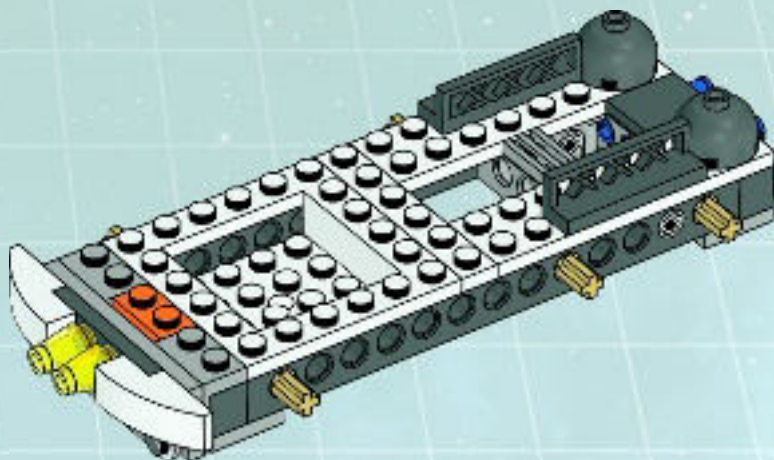

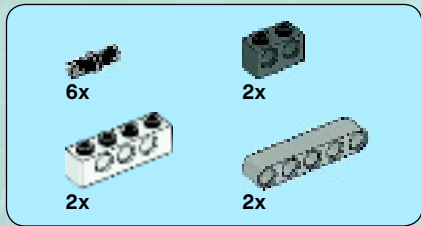

10

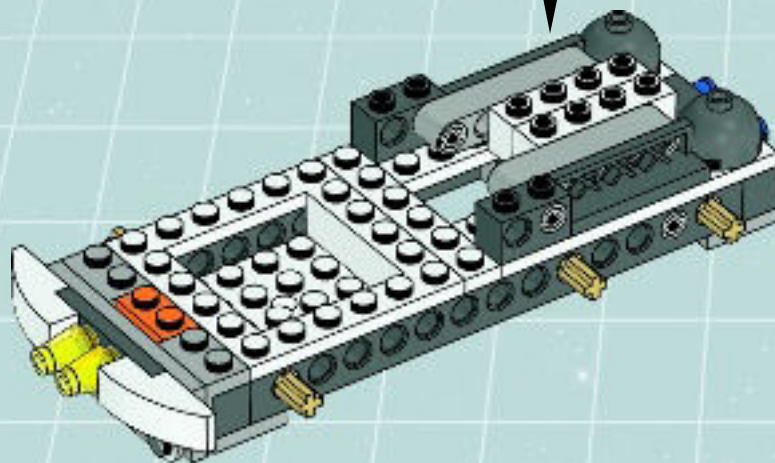
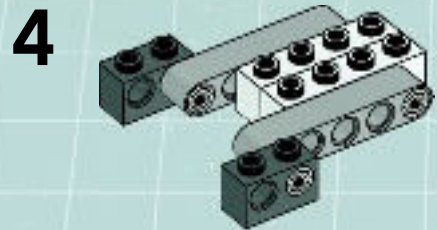
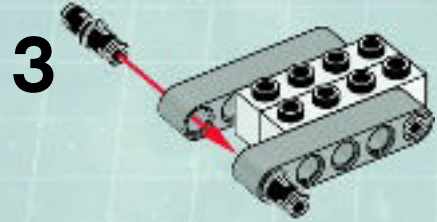



11

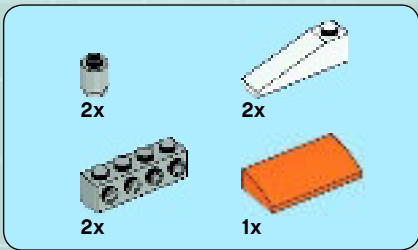
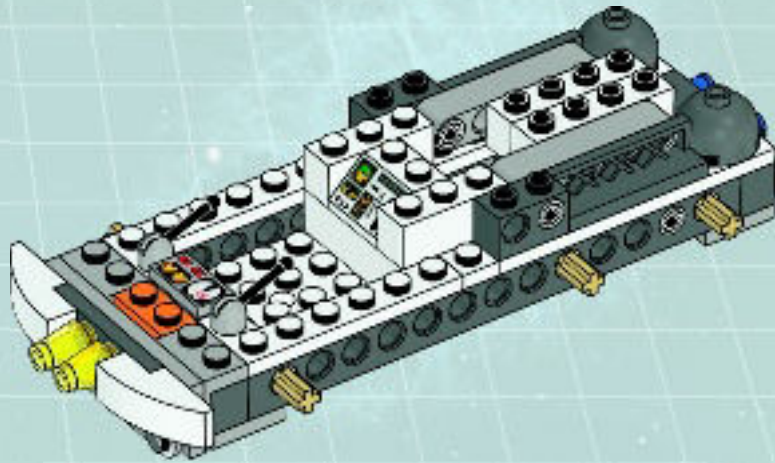

12

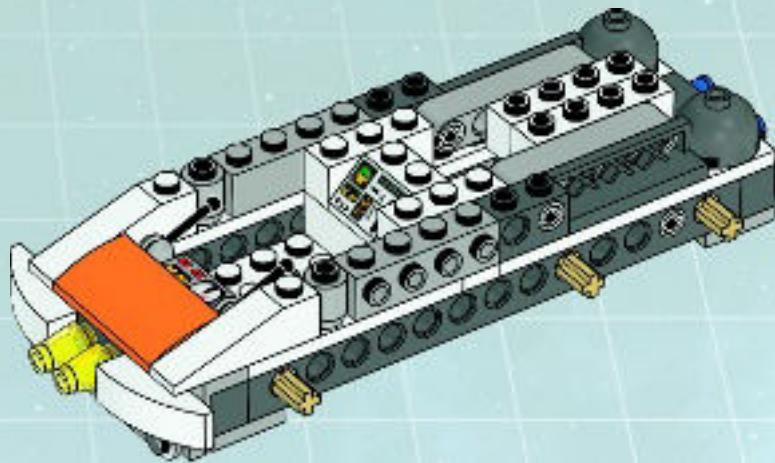

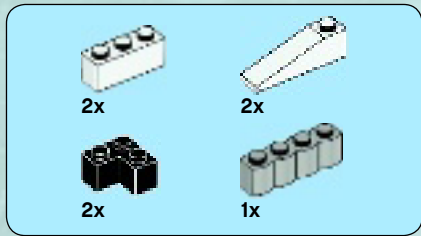

13

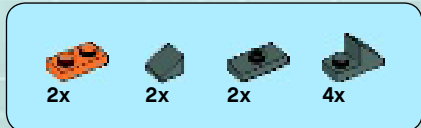
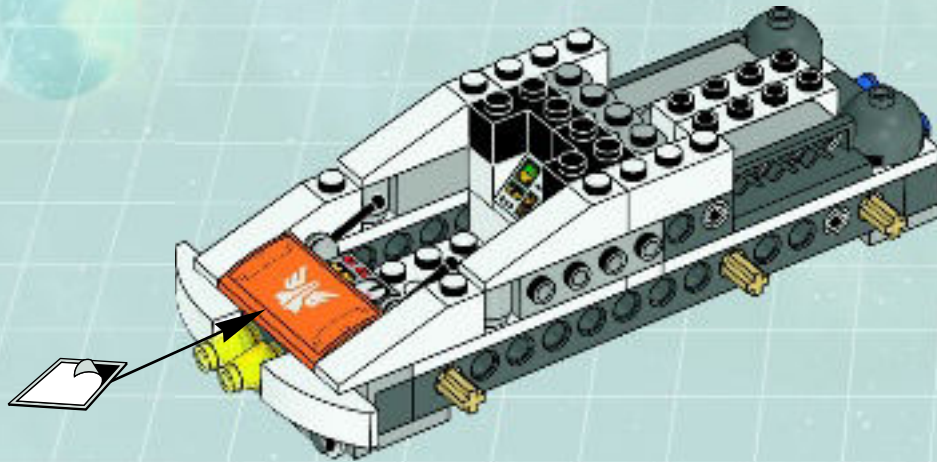

14

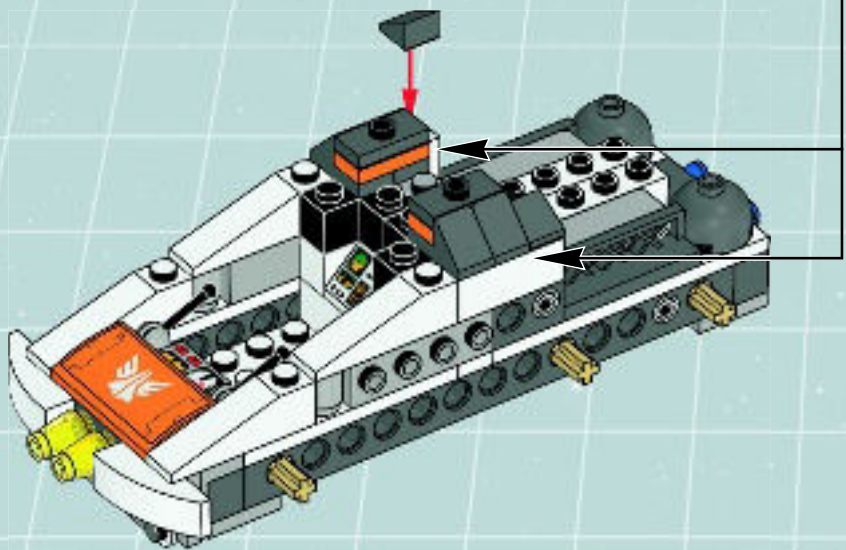



15

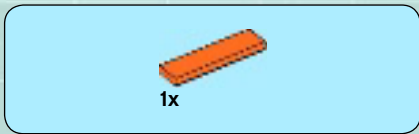
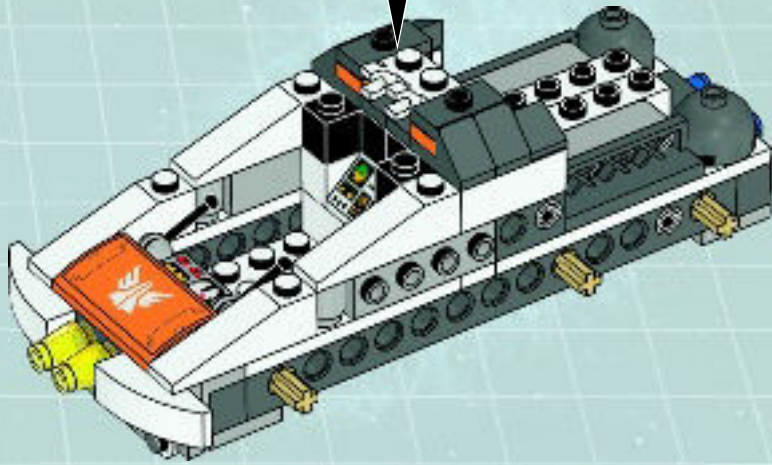

16

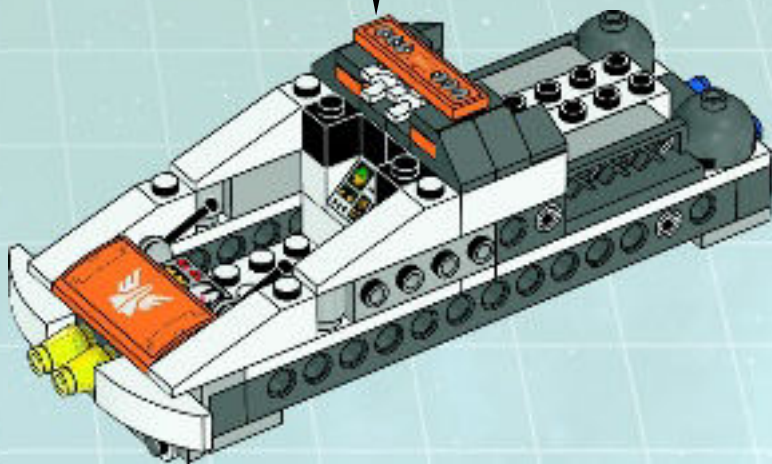
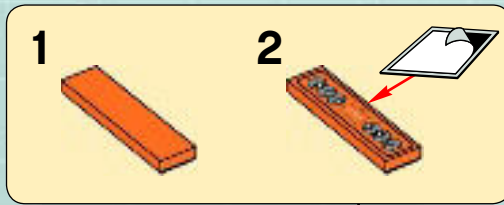

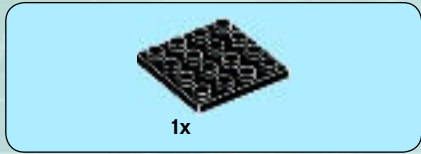

1



1x

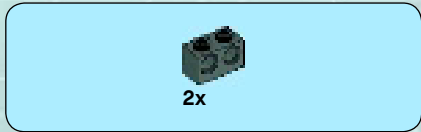

2x

2

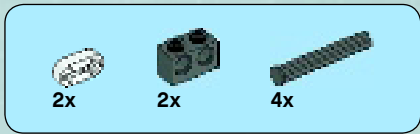

2x

2x

4x

3

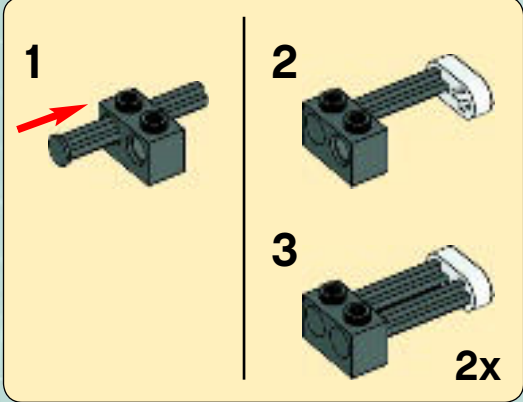

1

2

3

2x

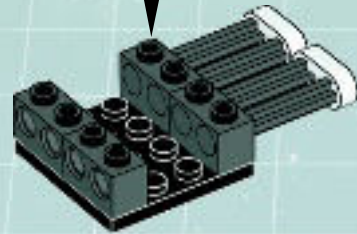

2x

4x

4

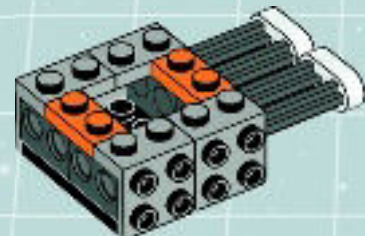

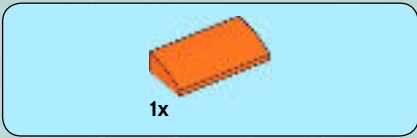

5

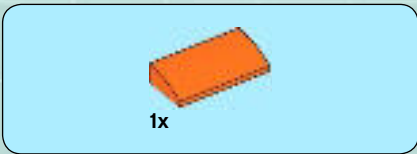
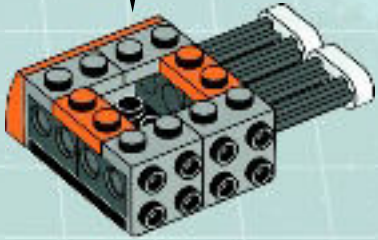
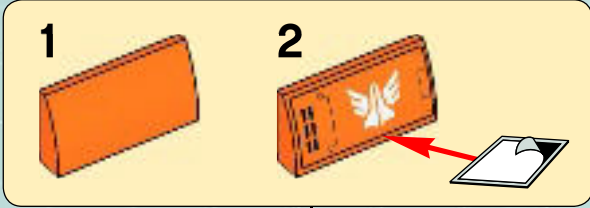

6

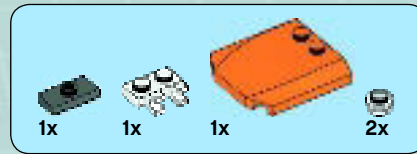
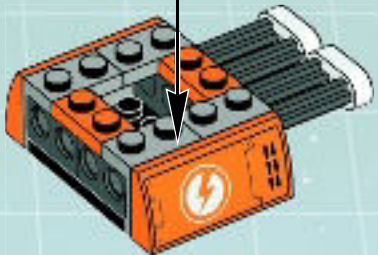
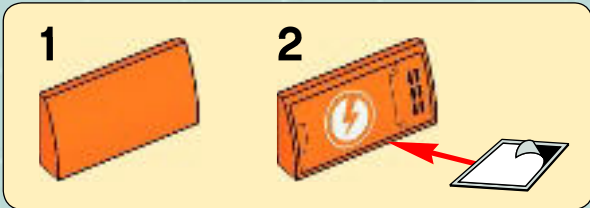

7

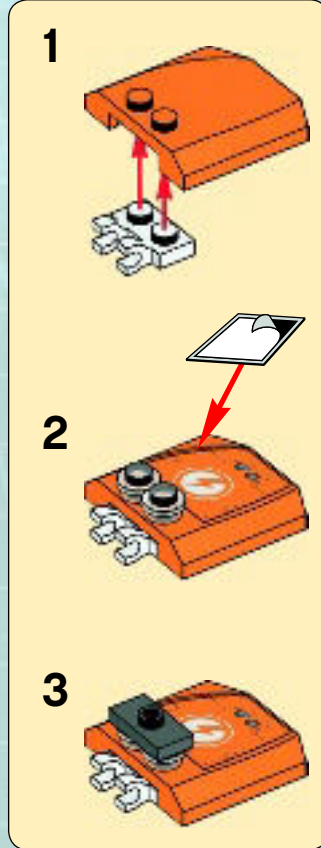

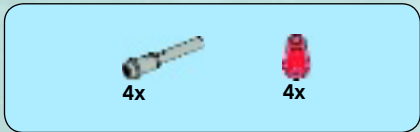

8

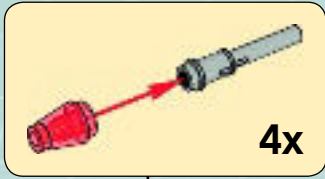

9

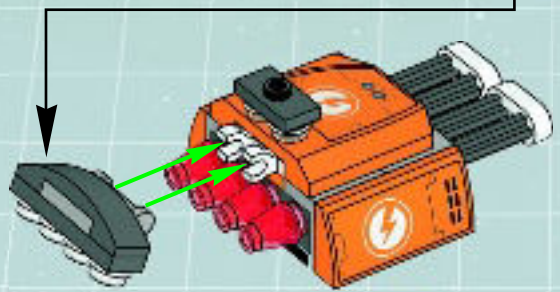
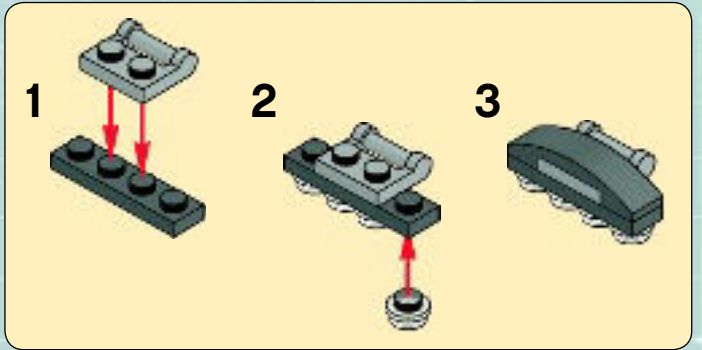

17

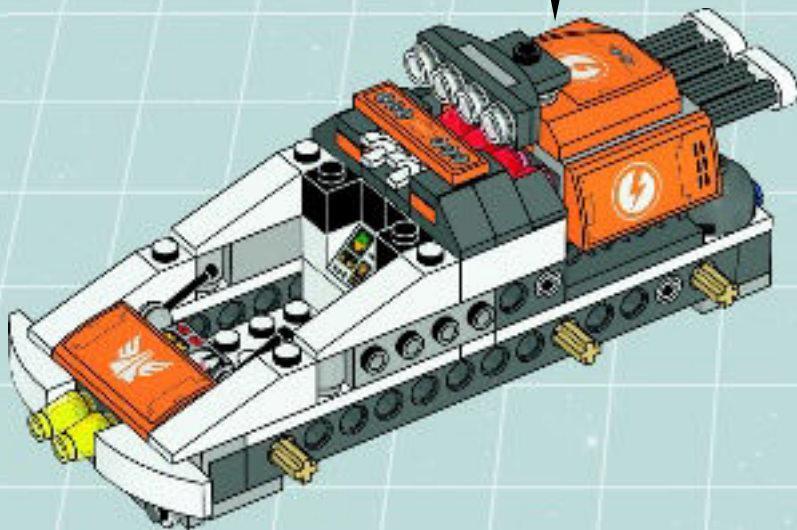



18

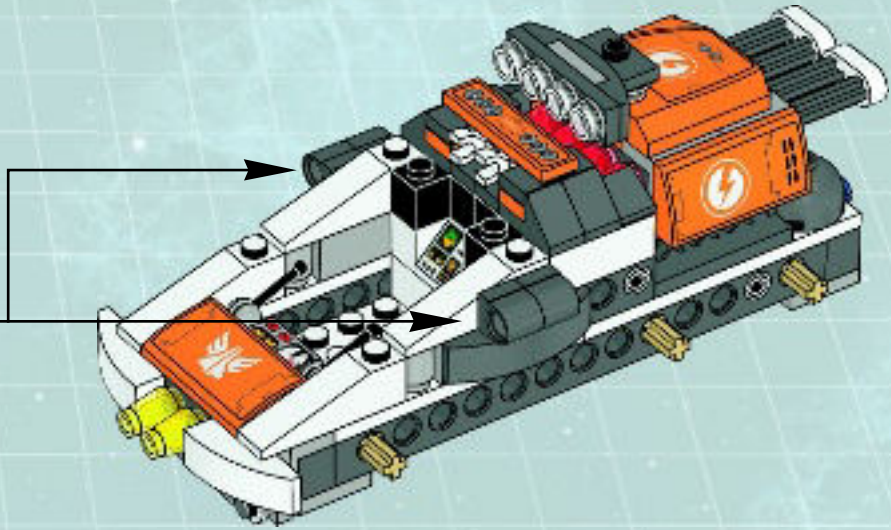
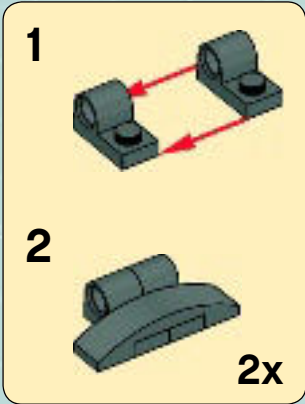

19

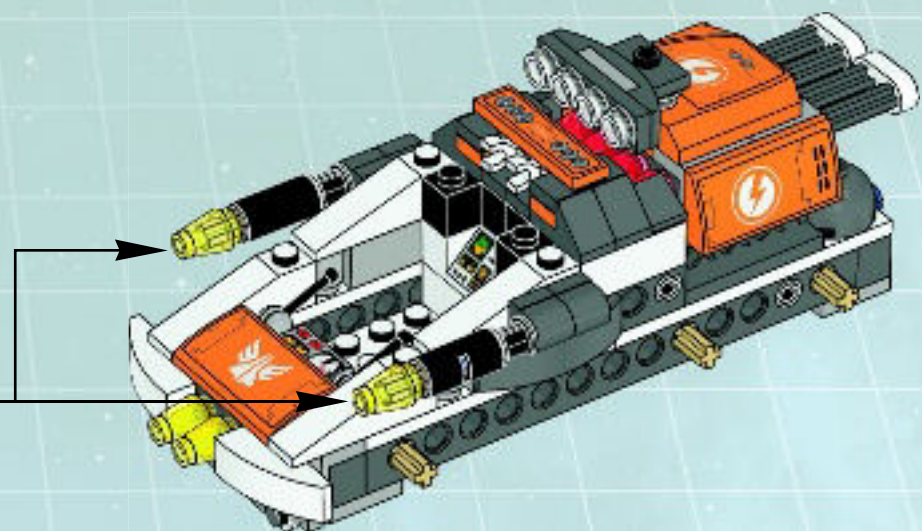
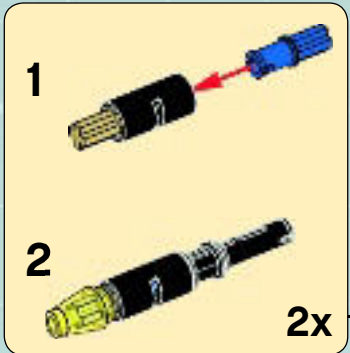



1x

20

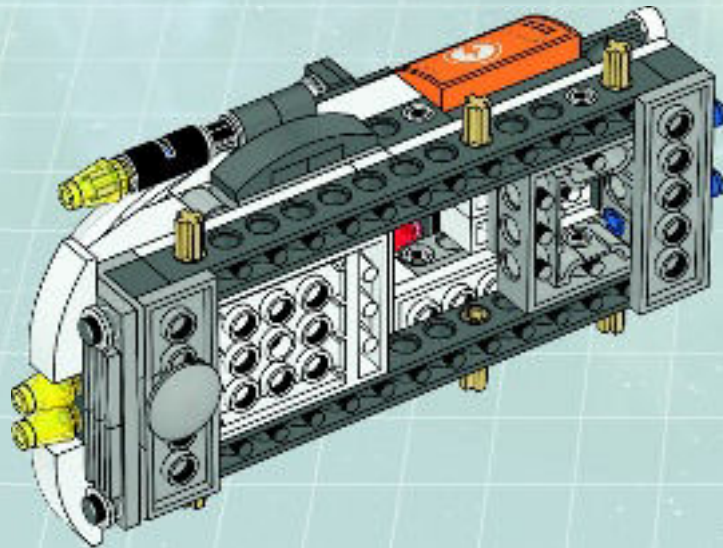
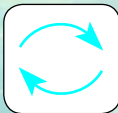

1x

21

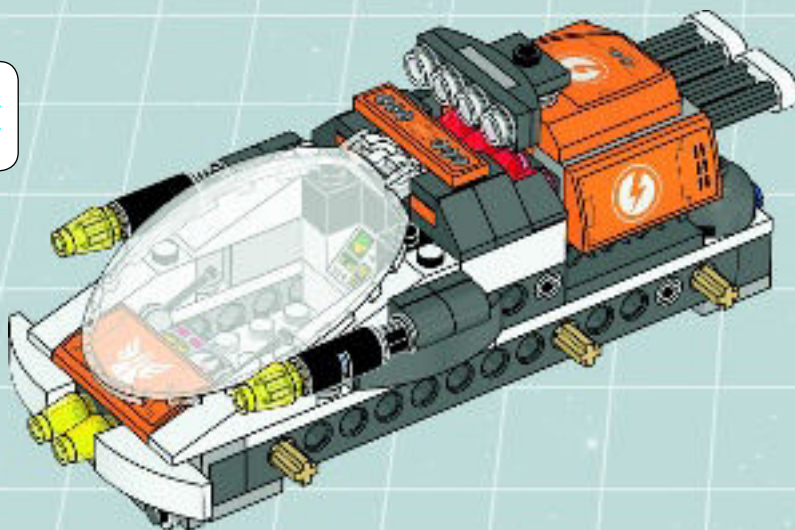
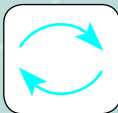

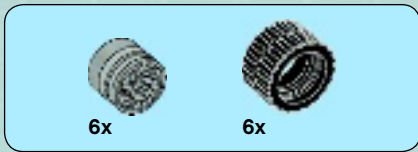

22

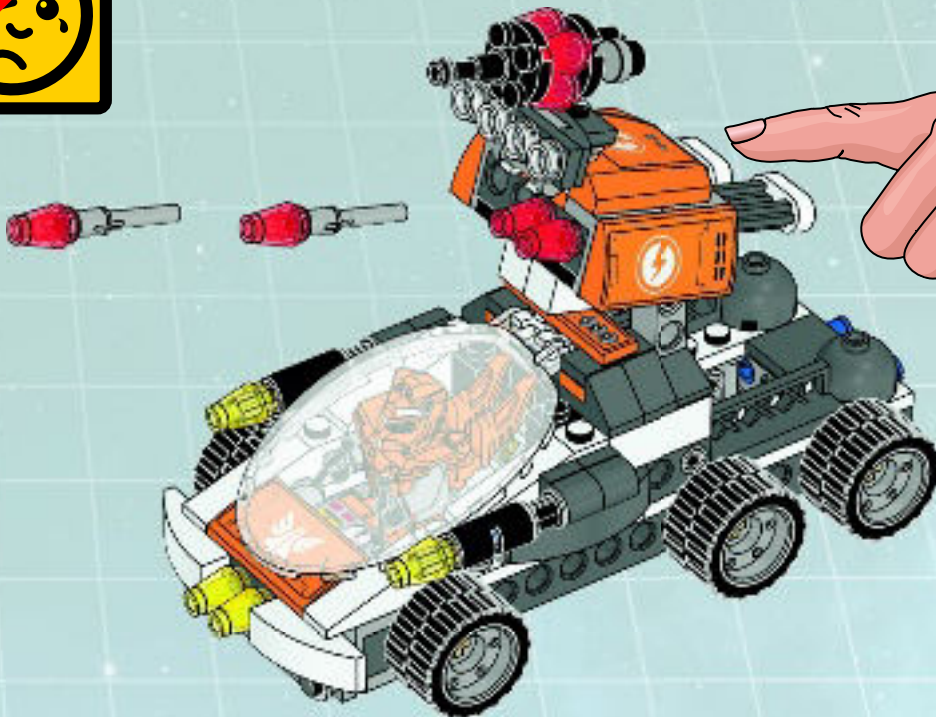
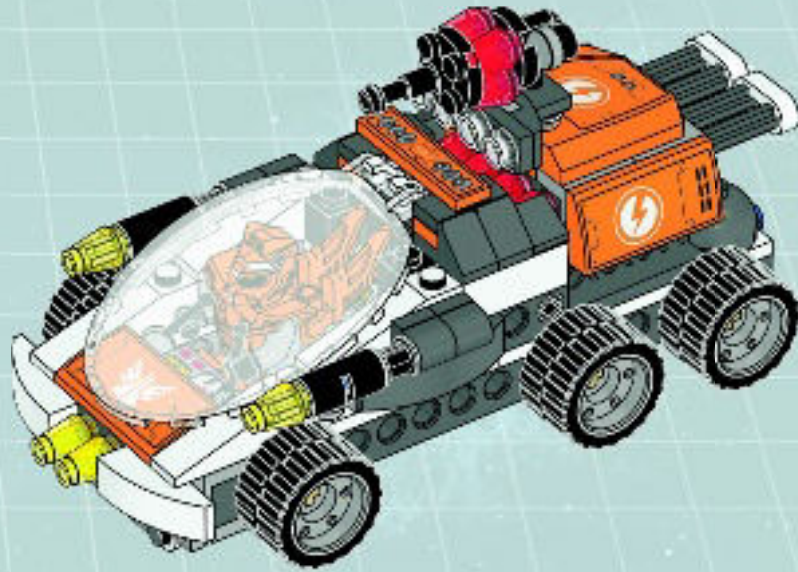

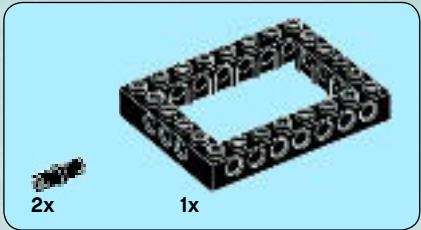

1

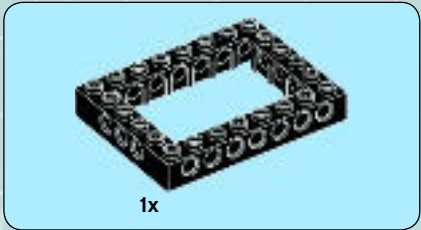
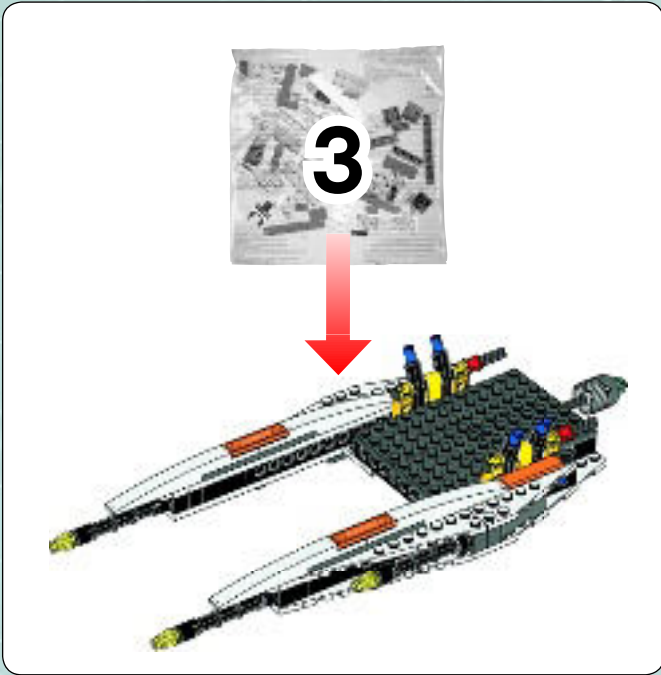
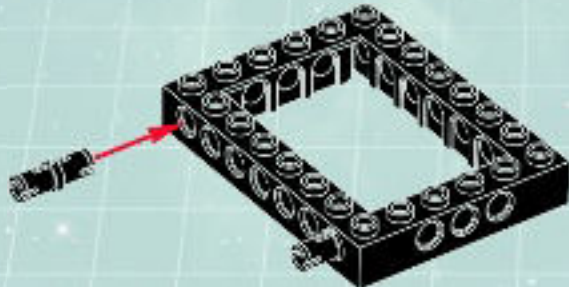

2

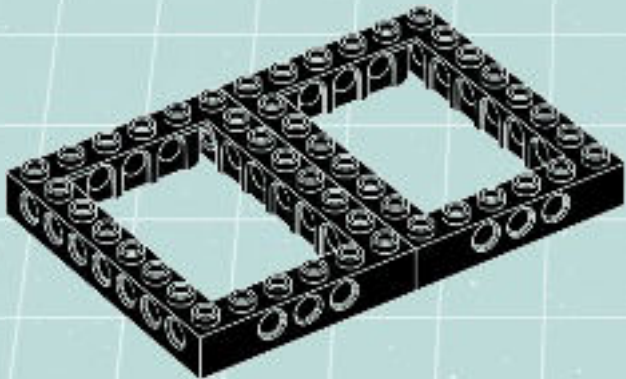

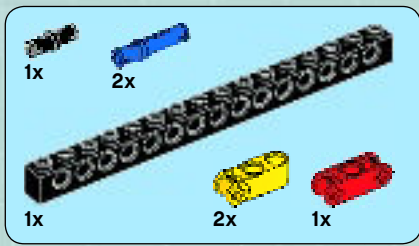

3

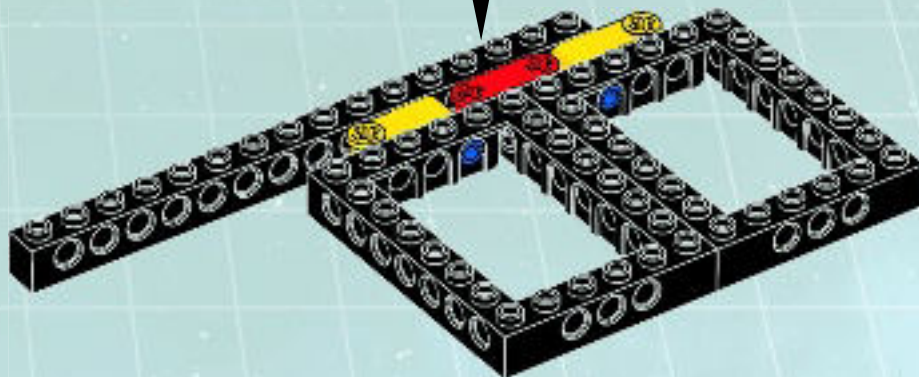
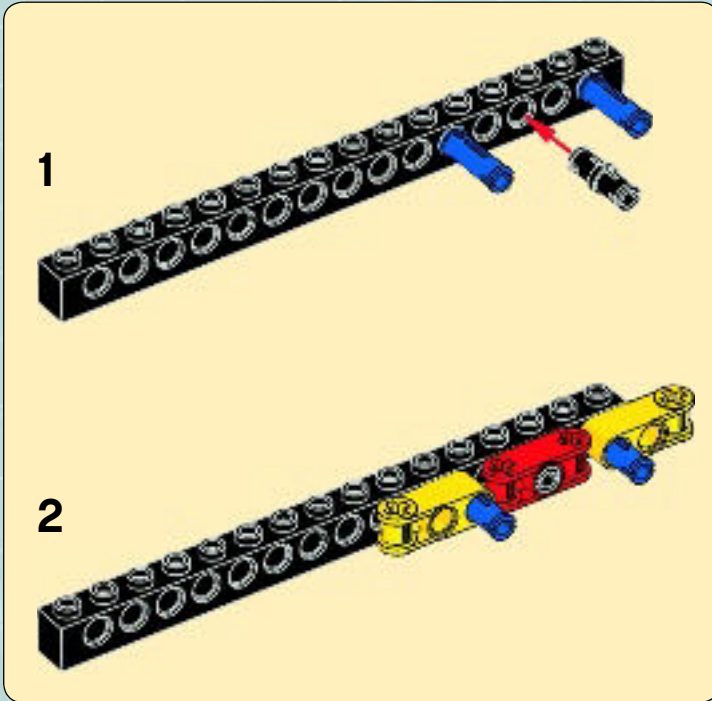

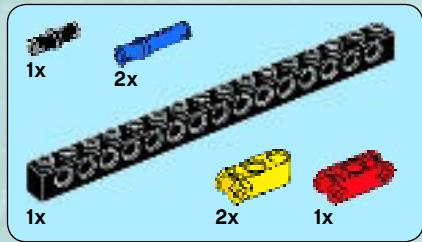

4

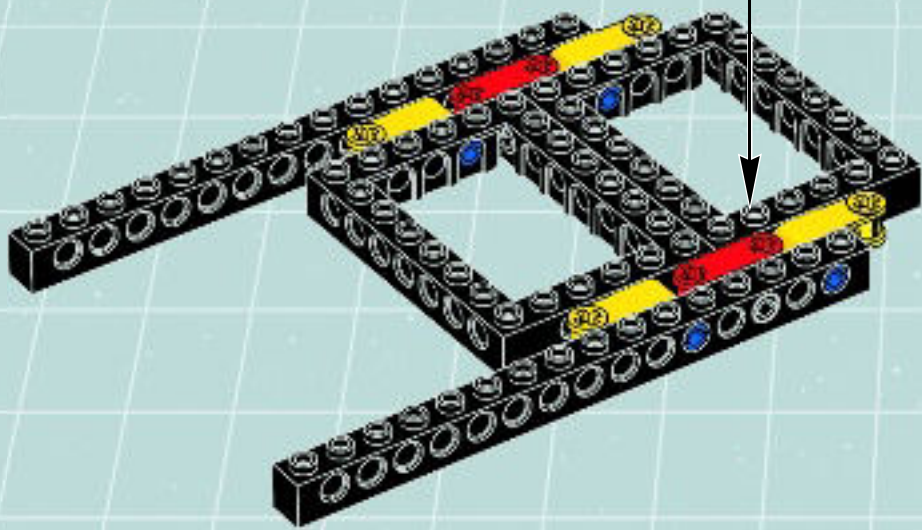
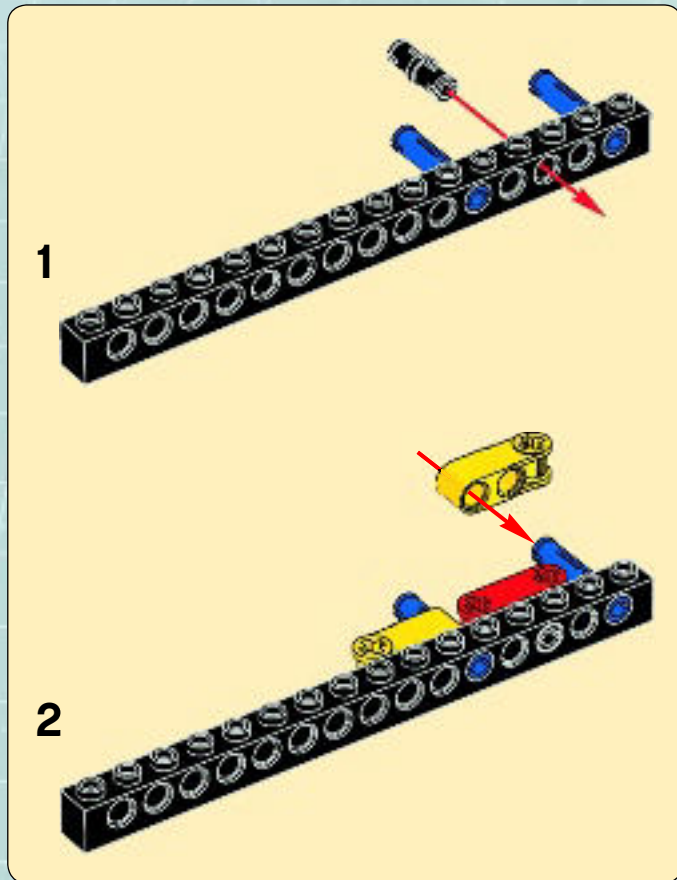



5

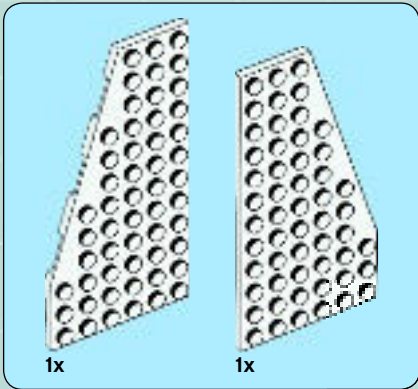
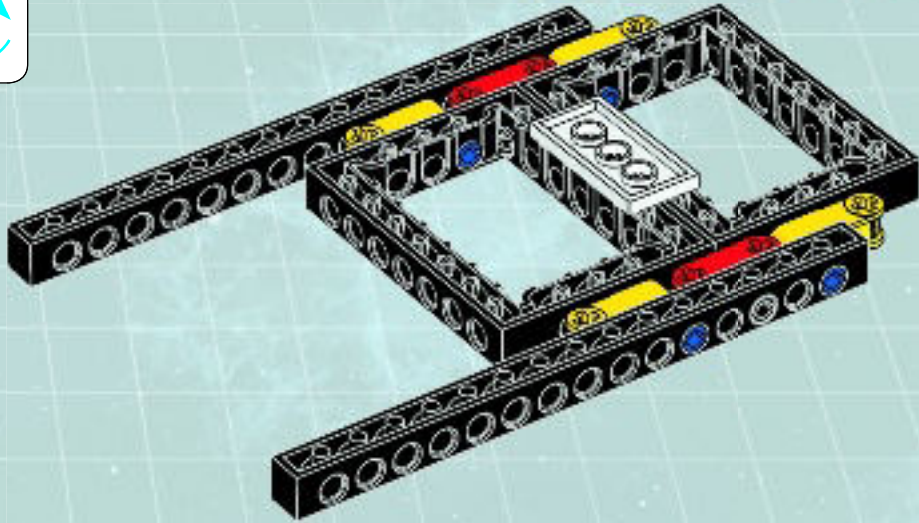

6

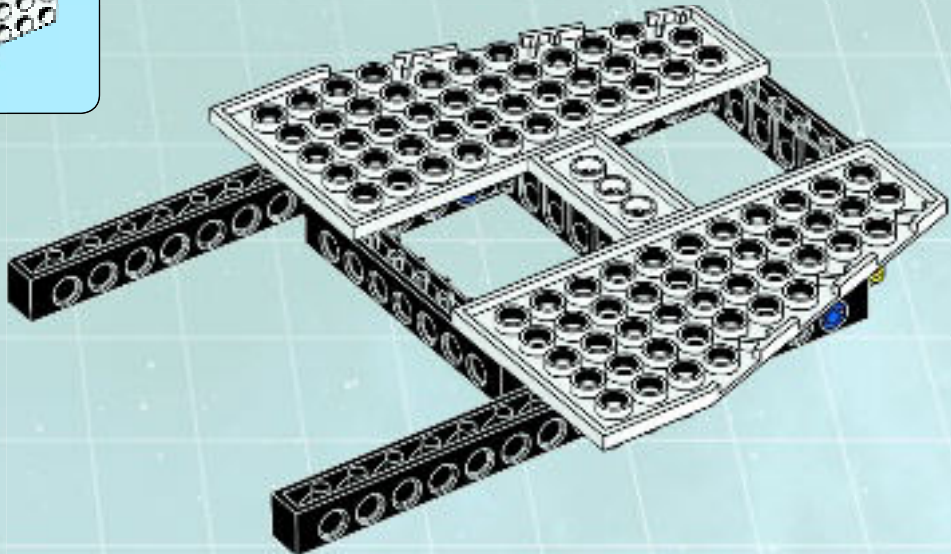

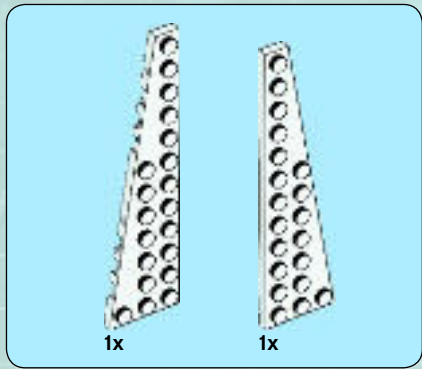

7

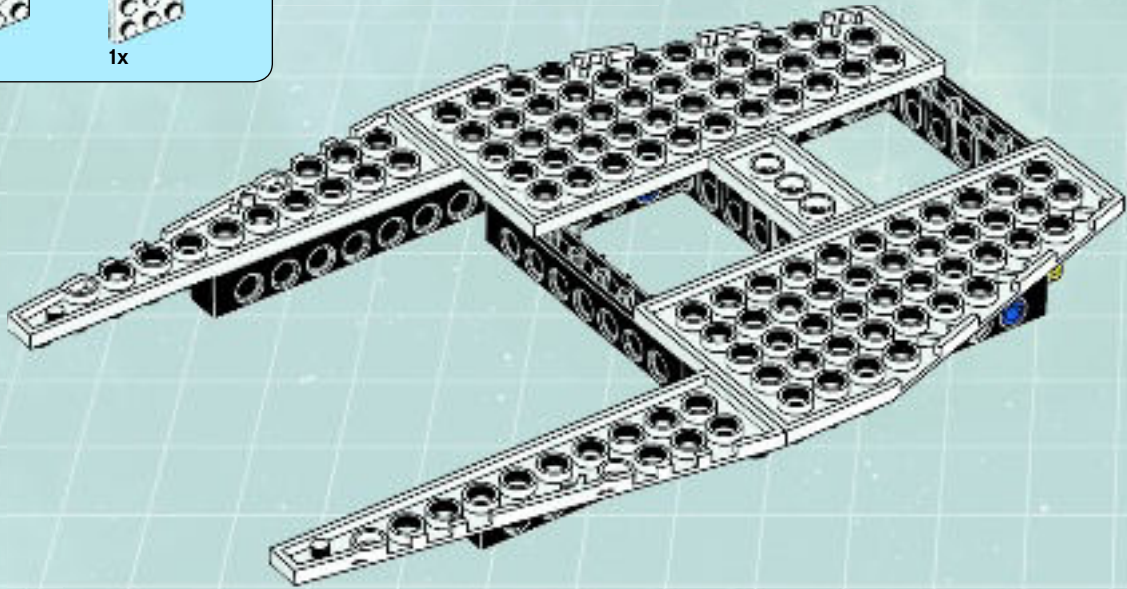

8

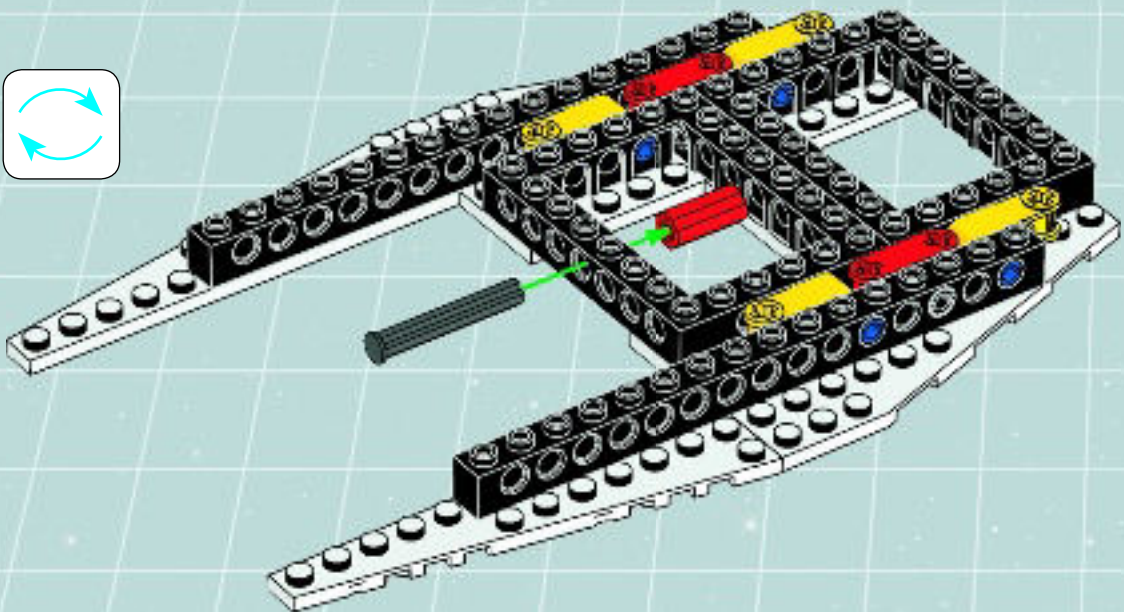

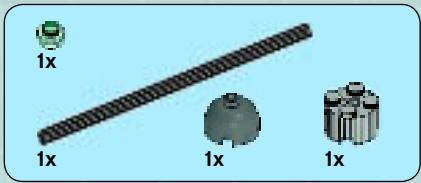

9

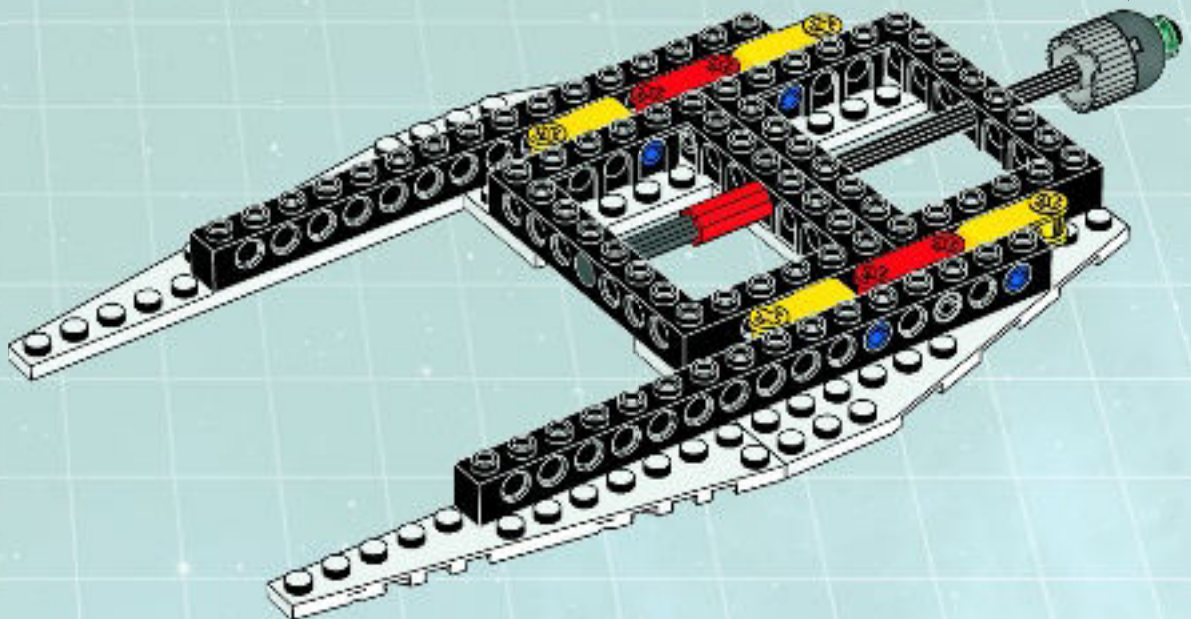
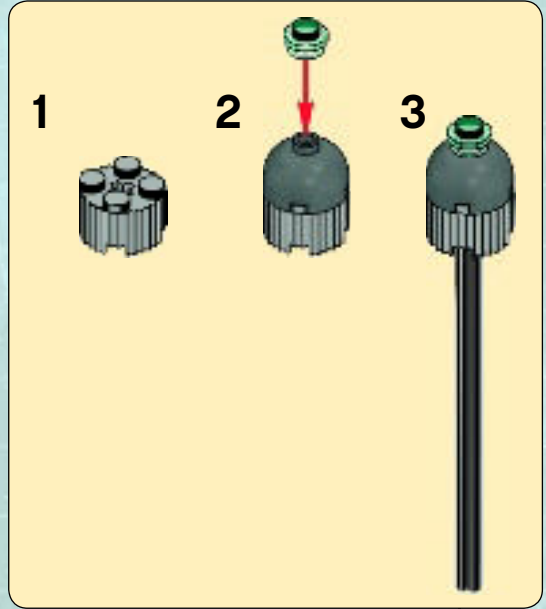



8x

10

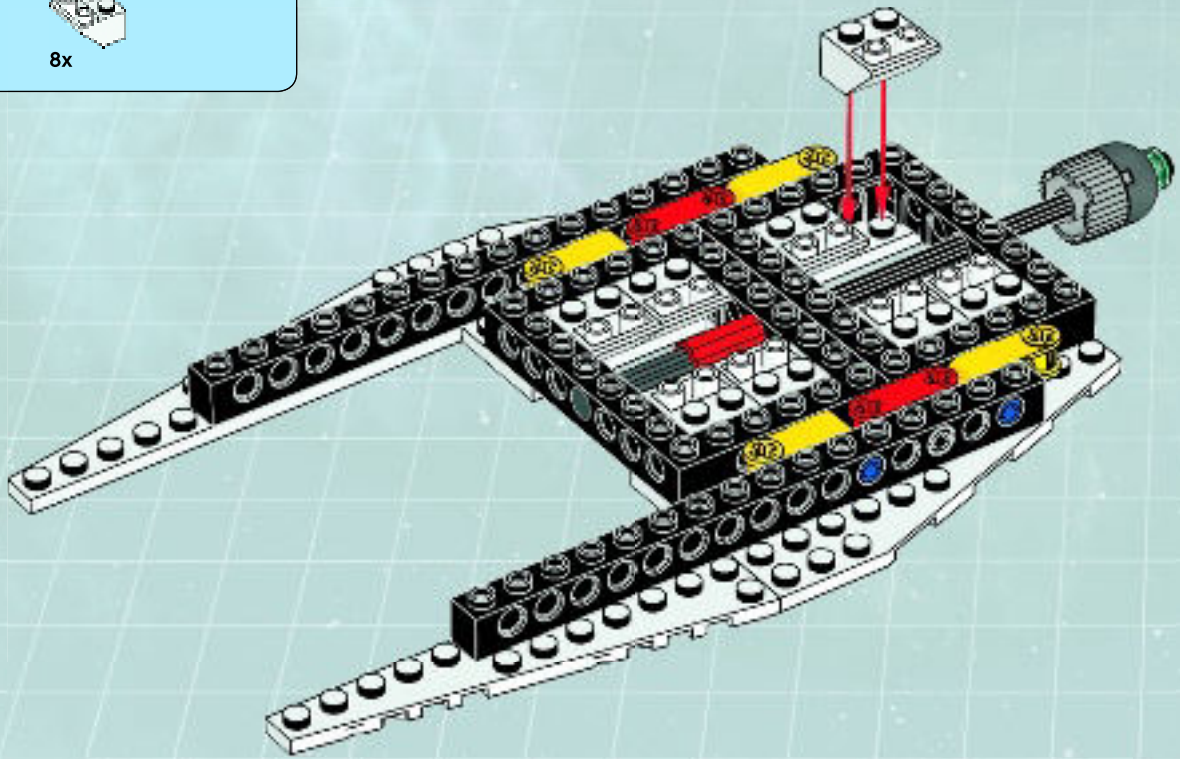

2x



4x

11

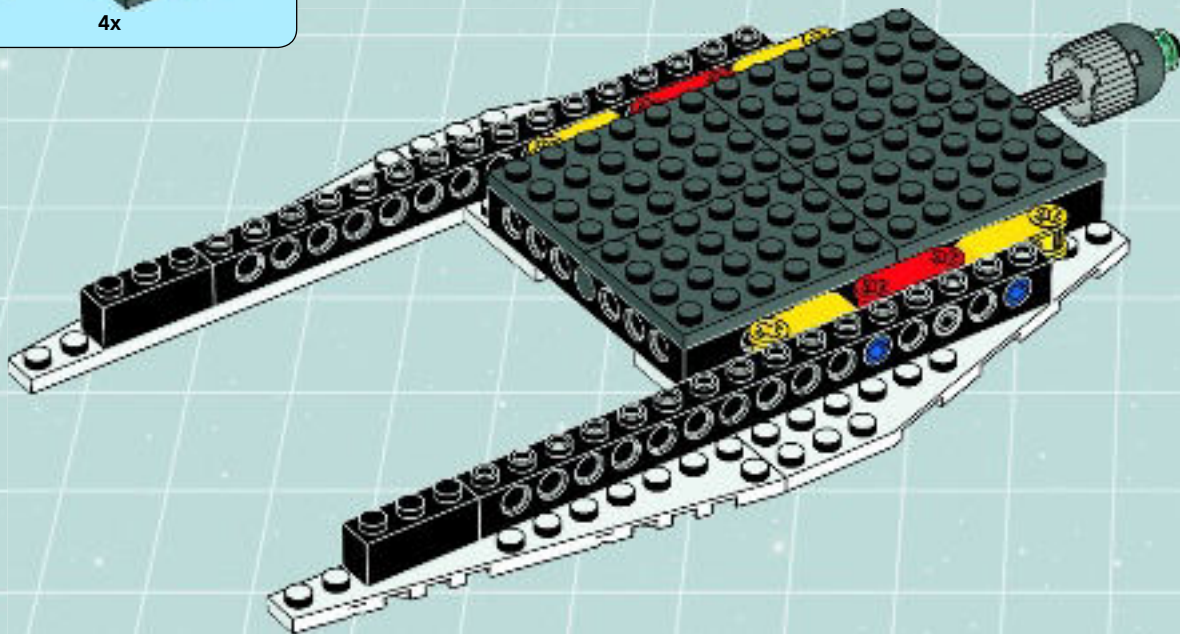

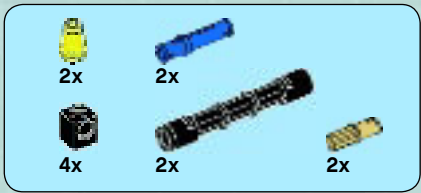

12

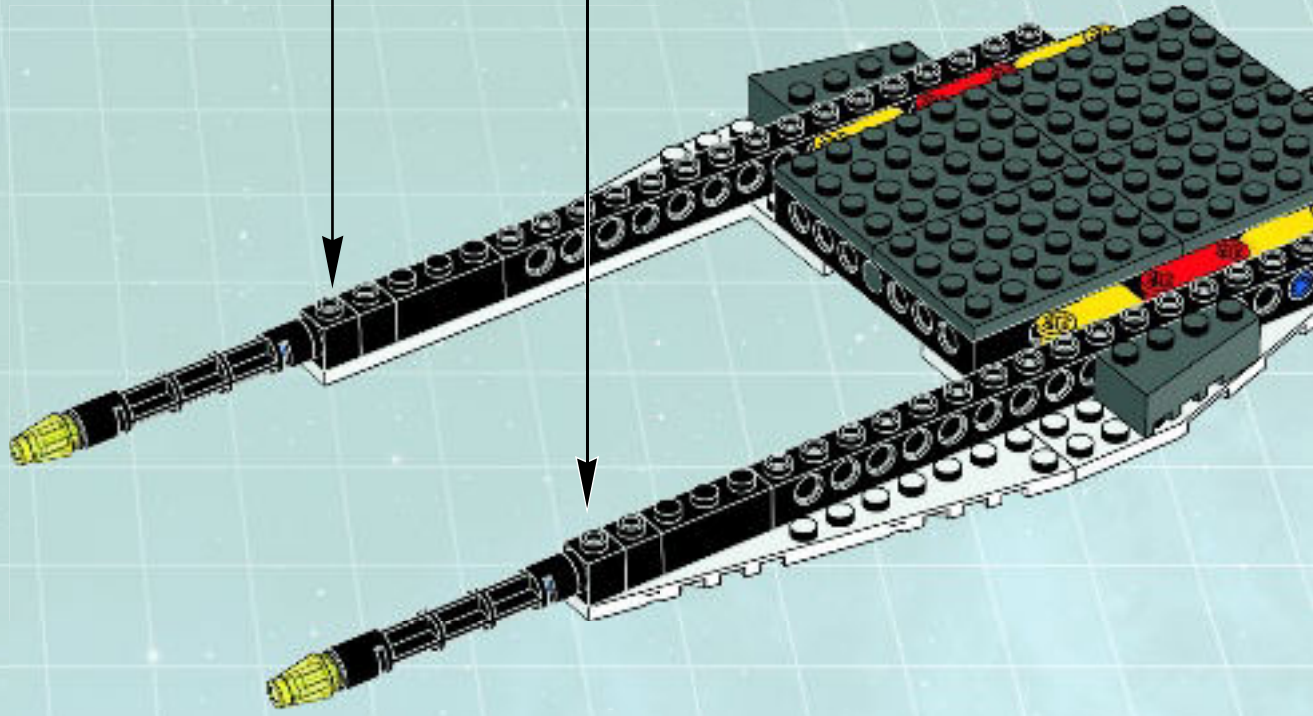
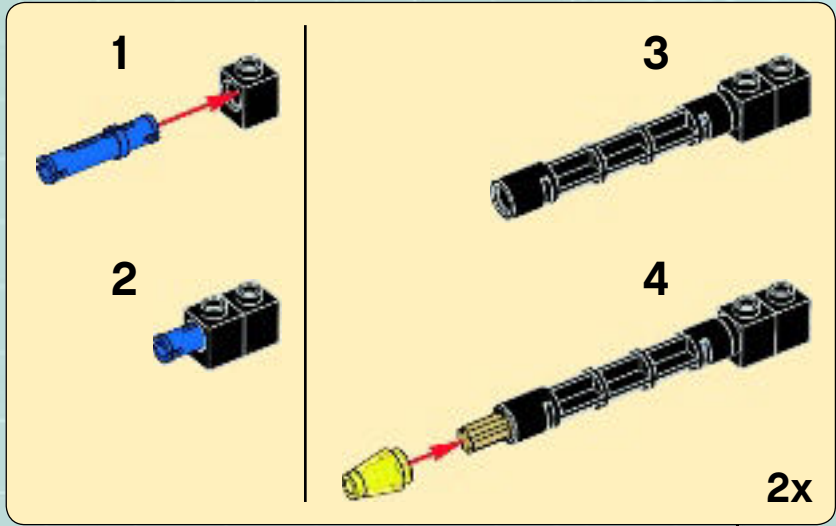

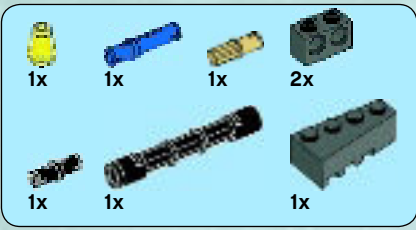

13

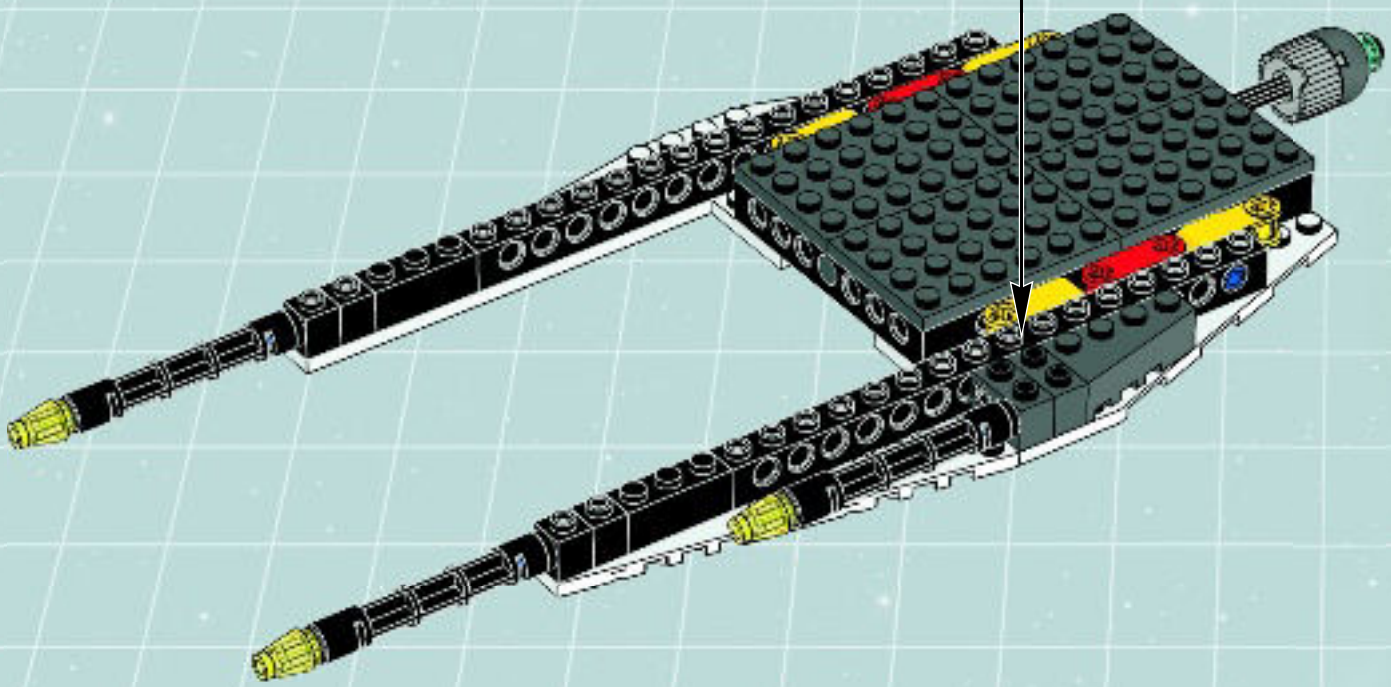
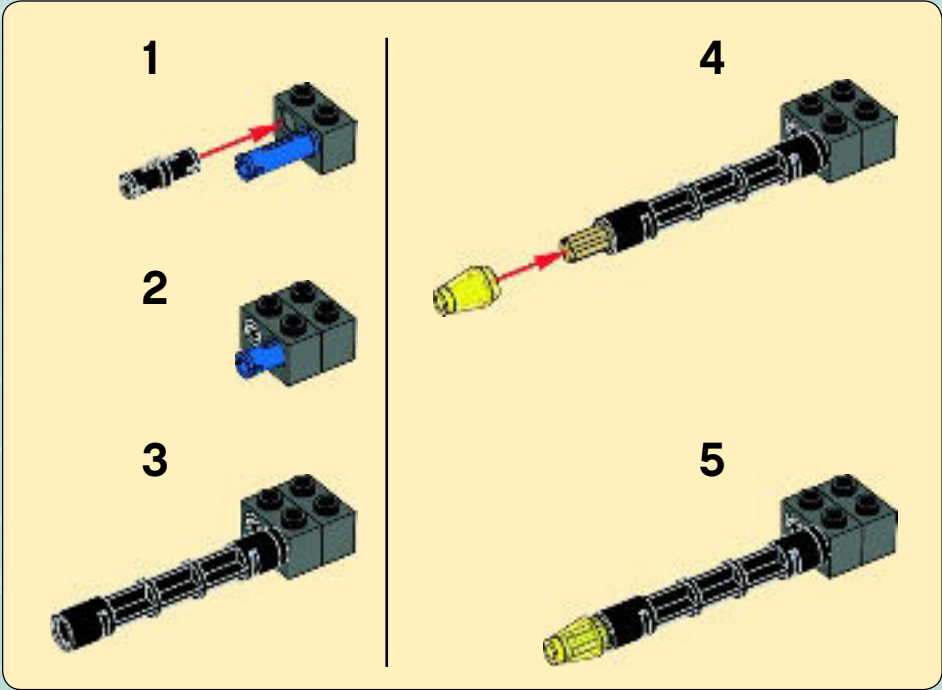

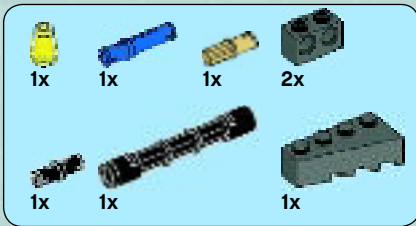

14

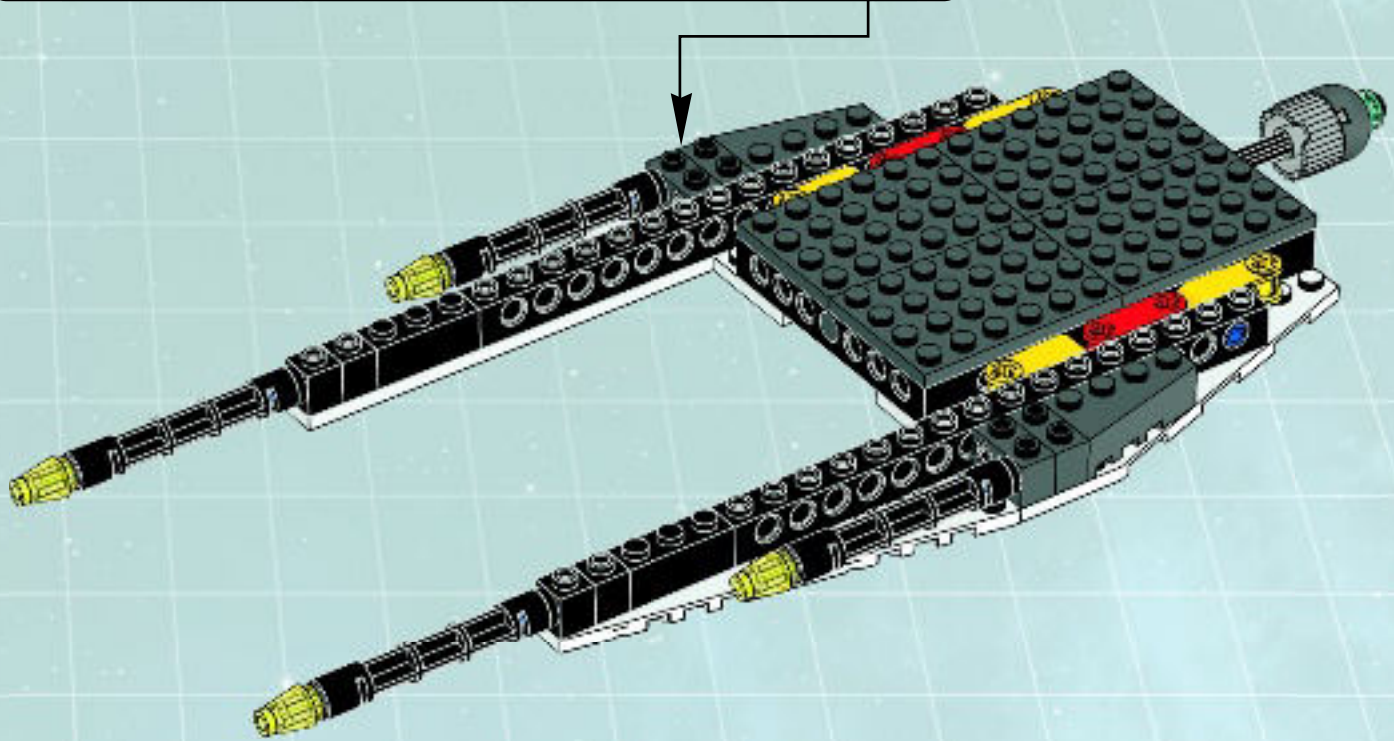
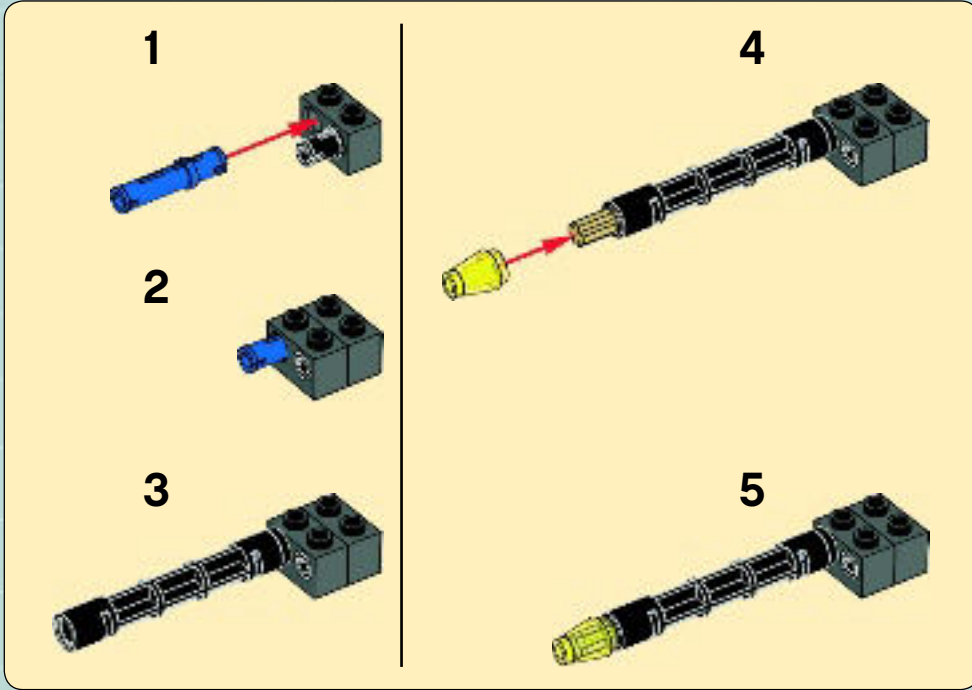

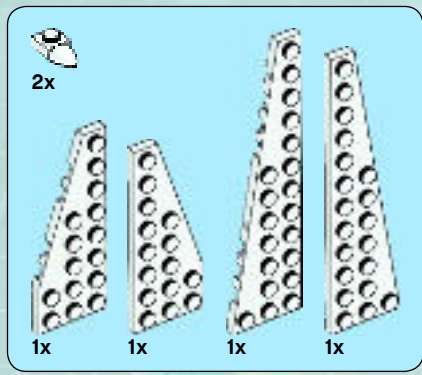

15

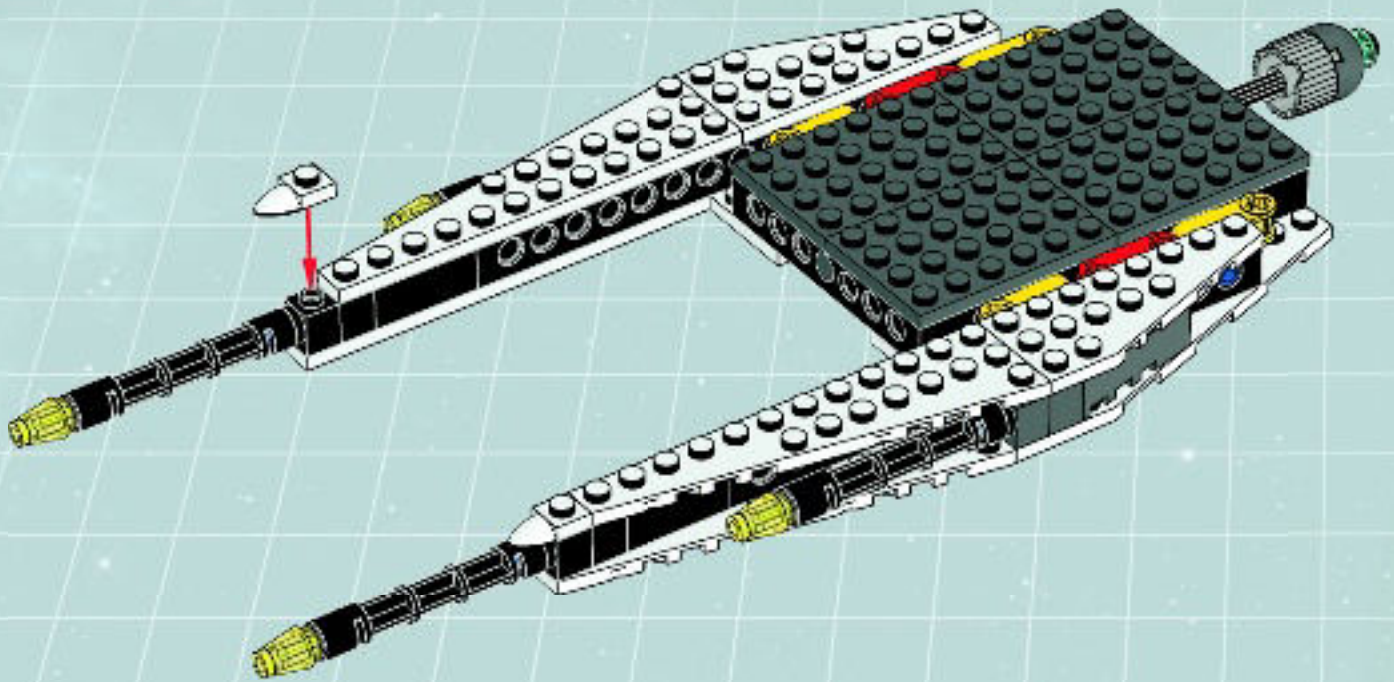

2x 6x

16

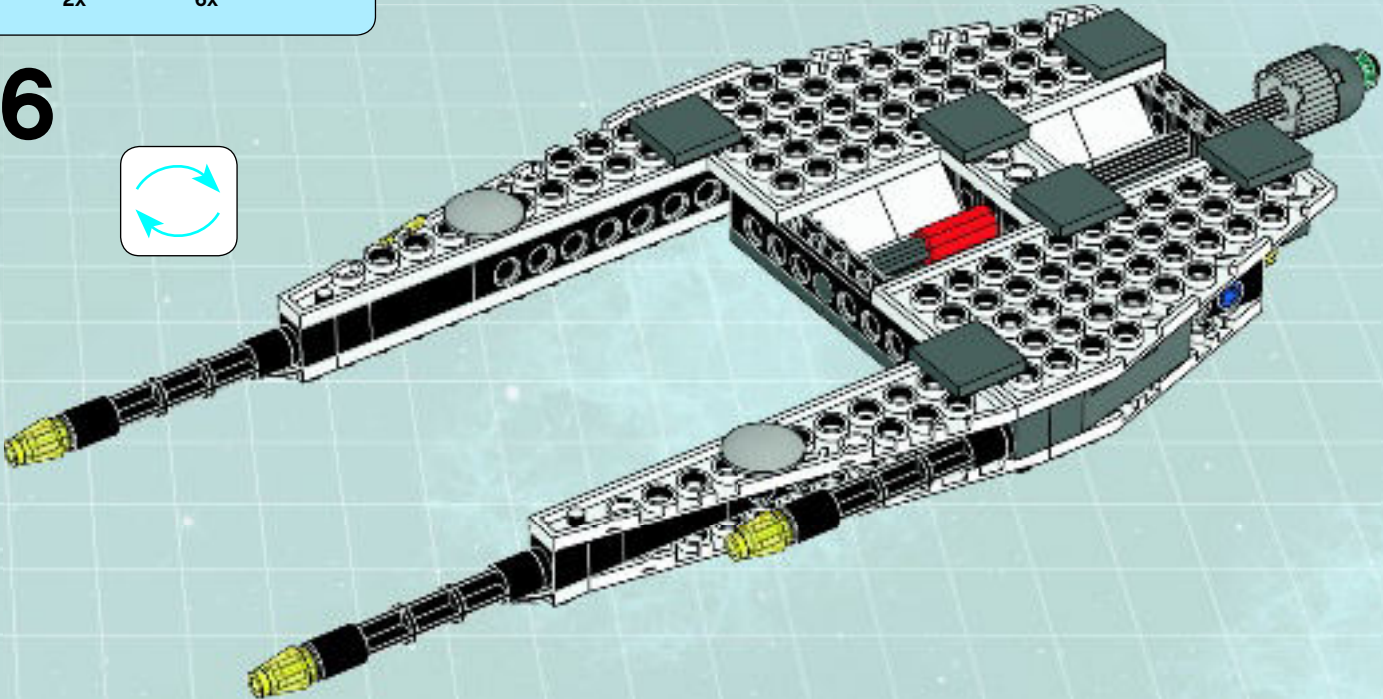
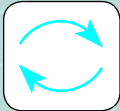

2x 2x

17

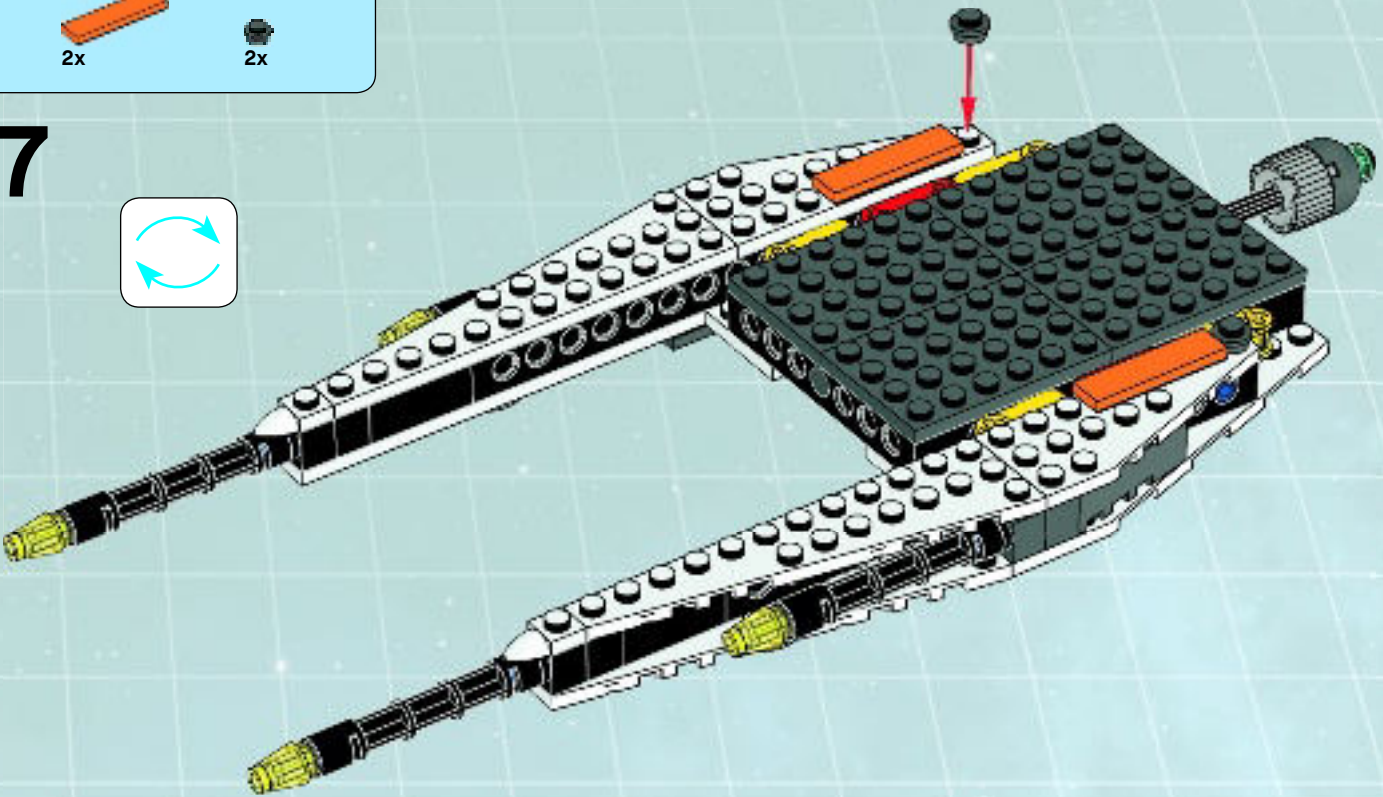

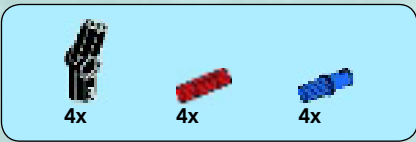

18

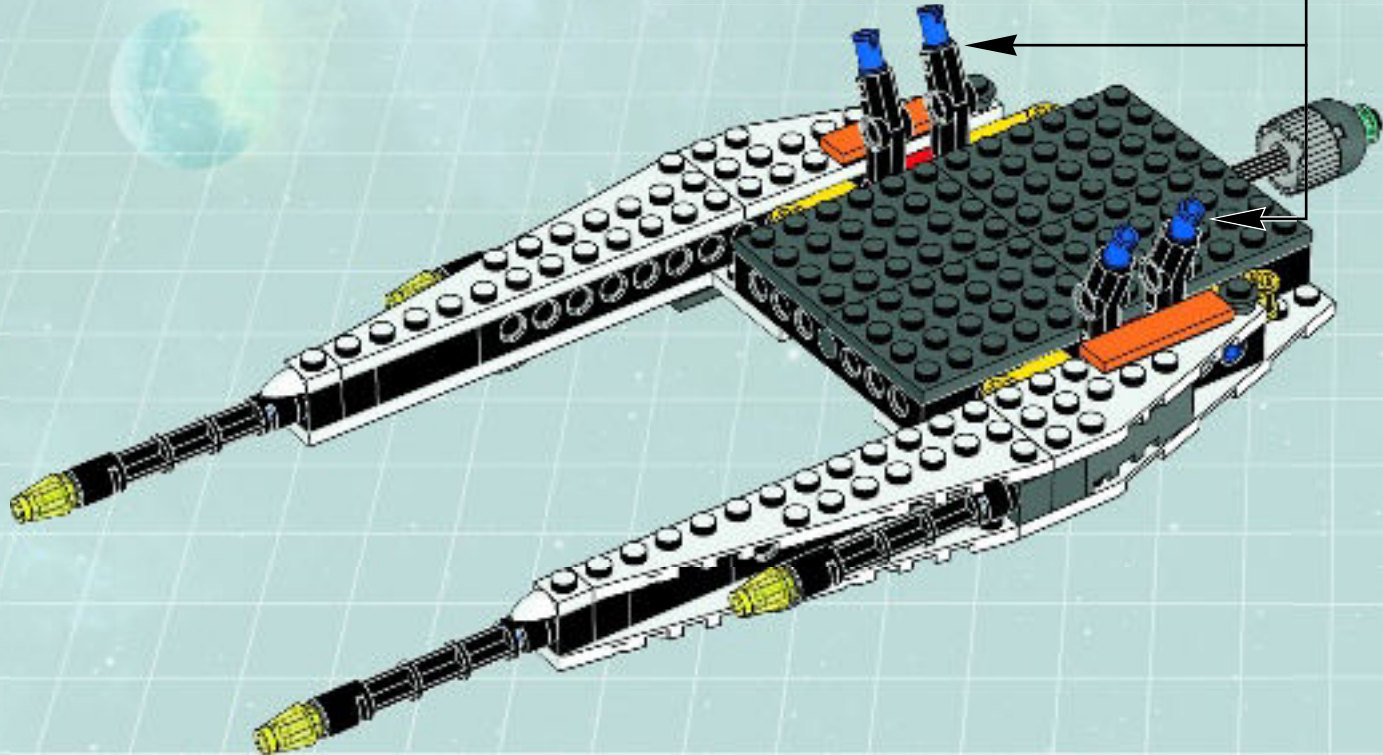

19

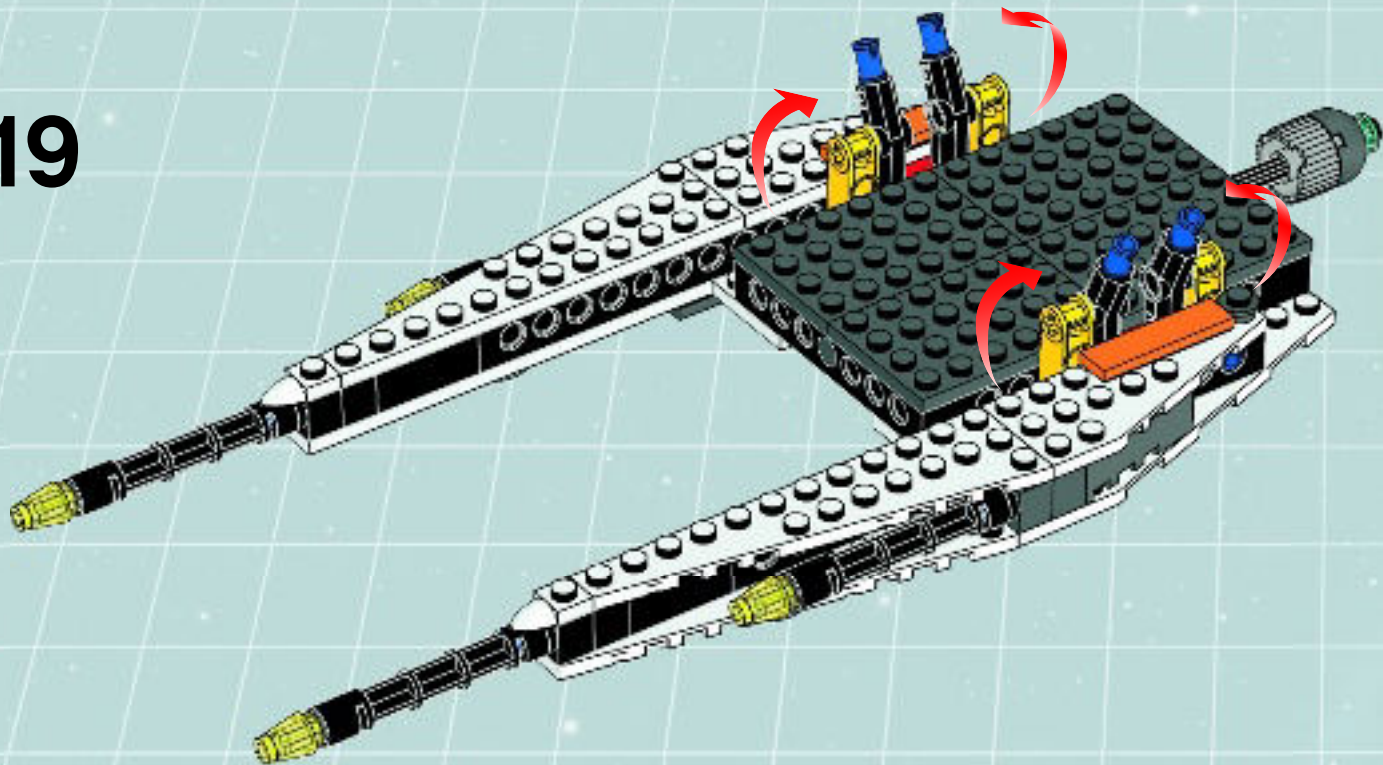

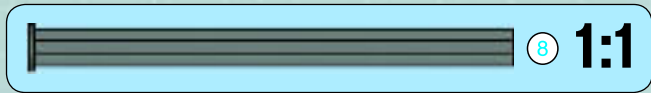
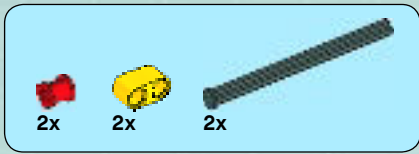

20

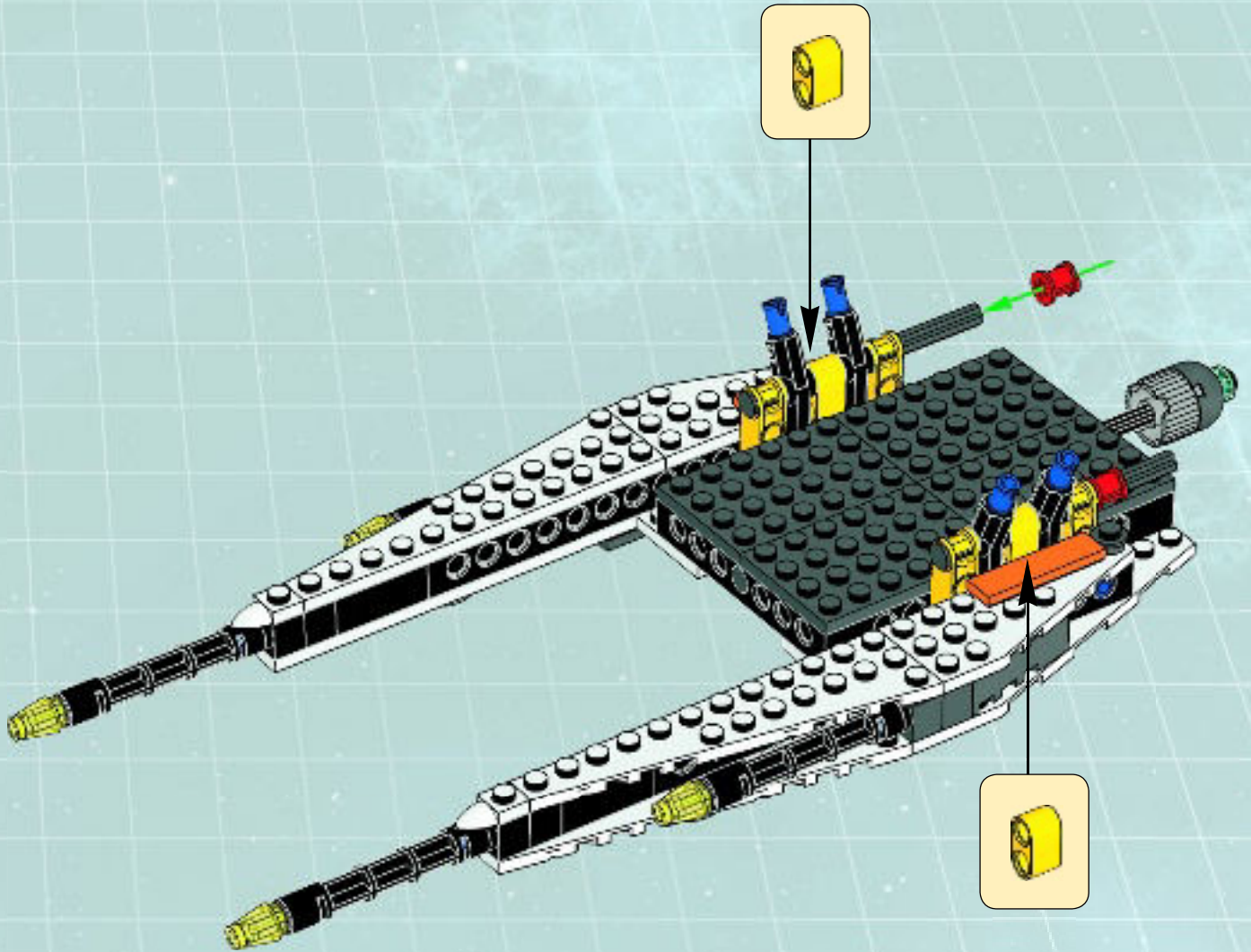

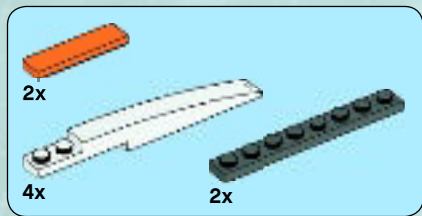

21

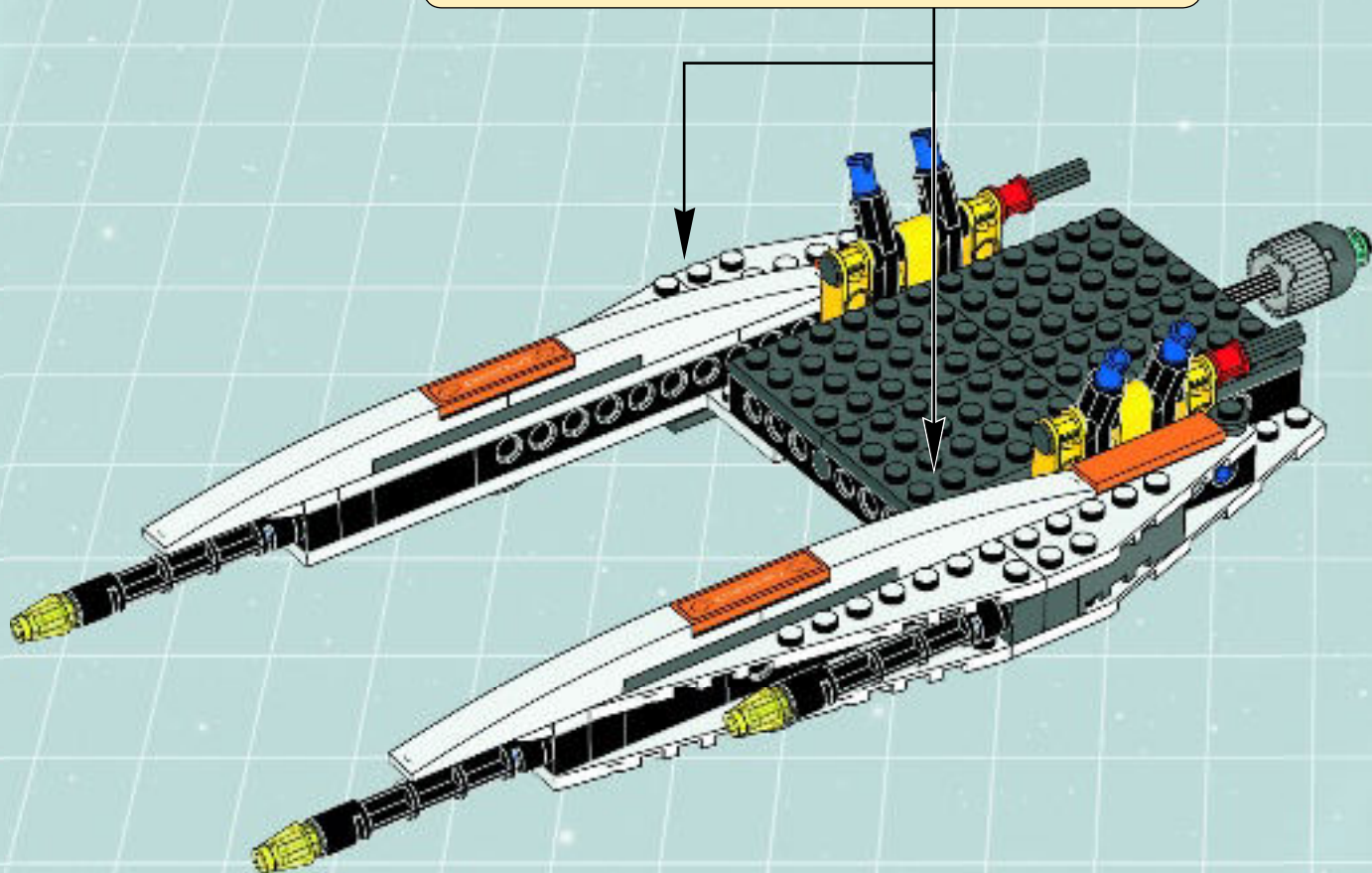
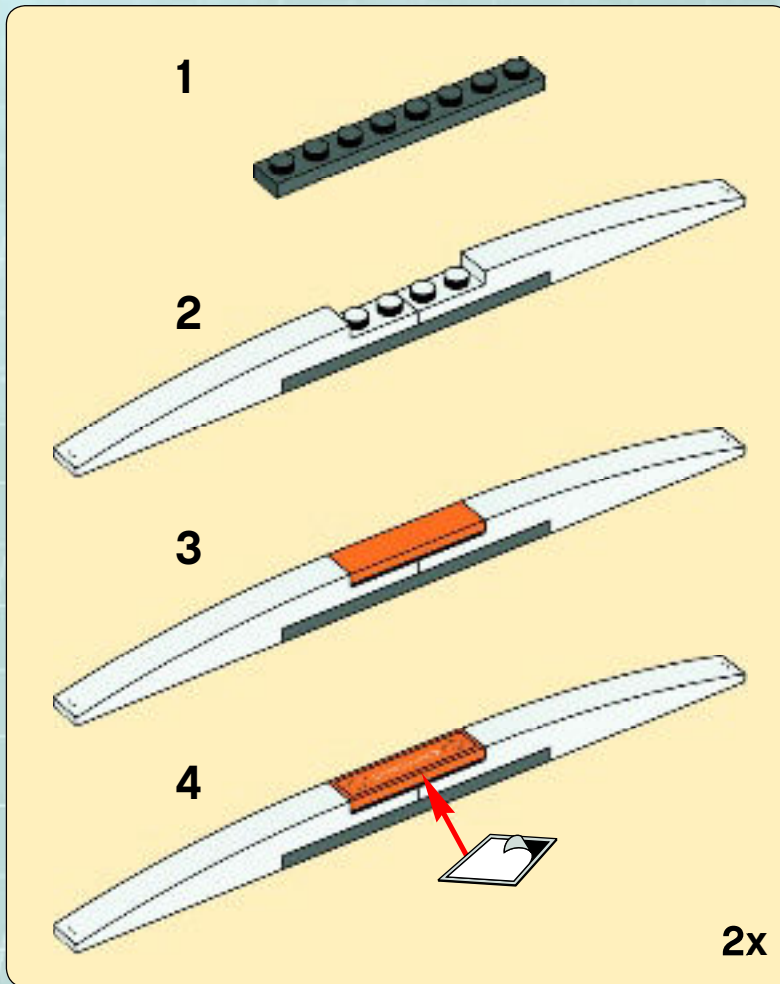

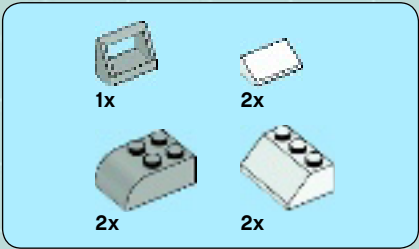
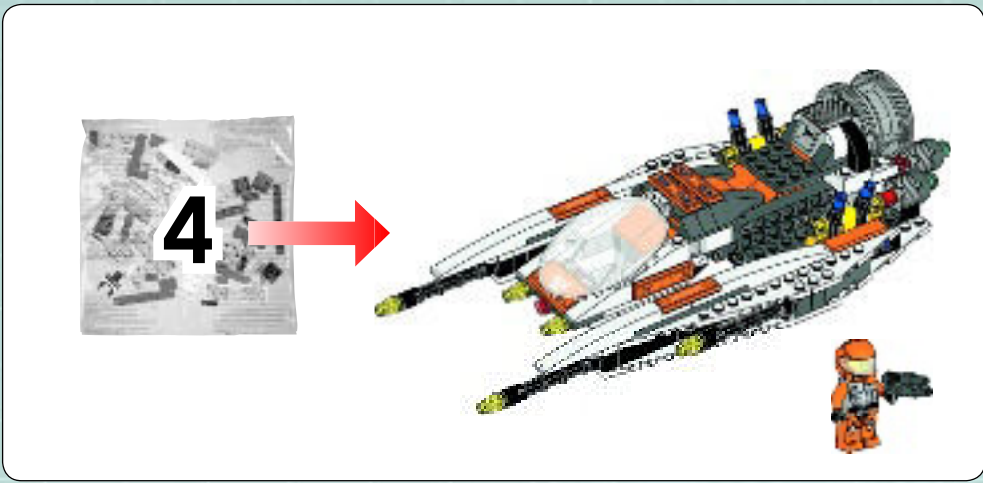

22

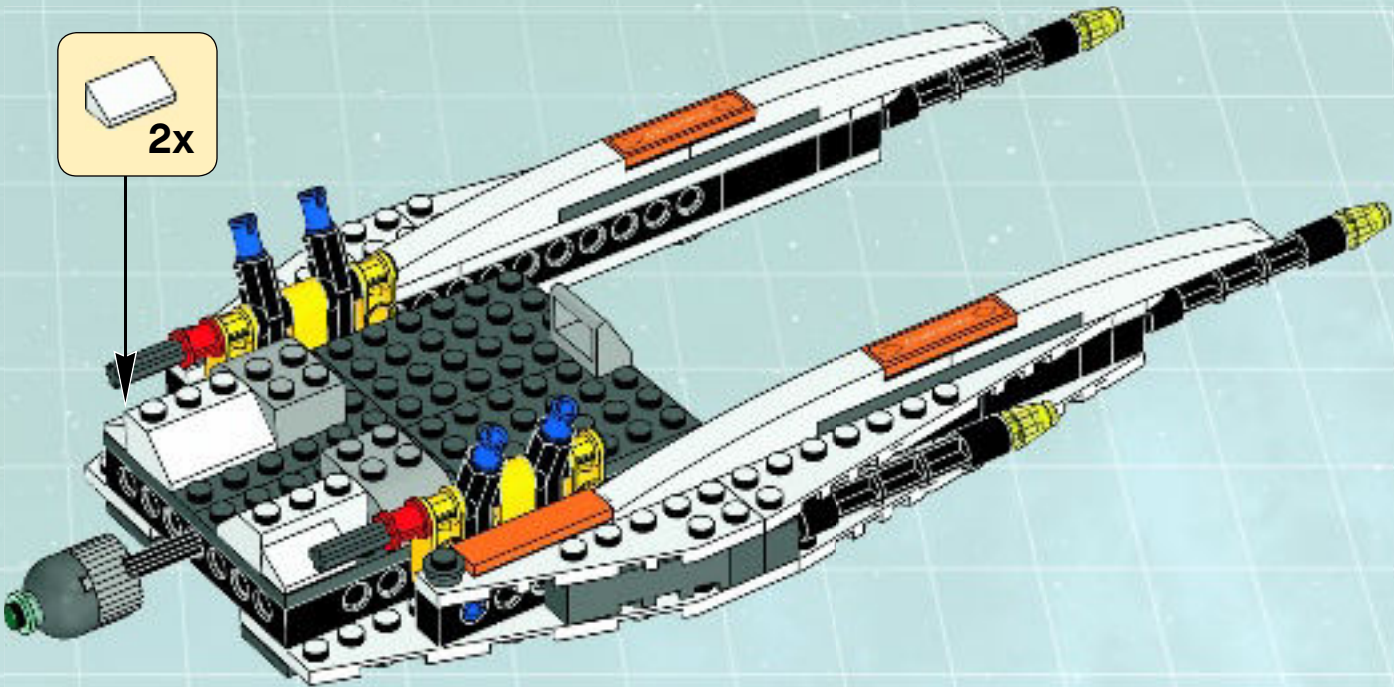
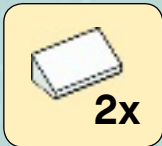
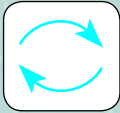

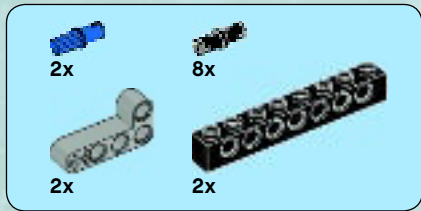

23

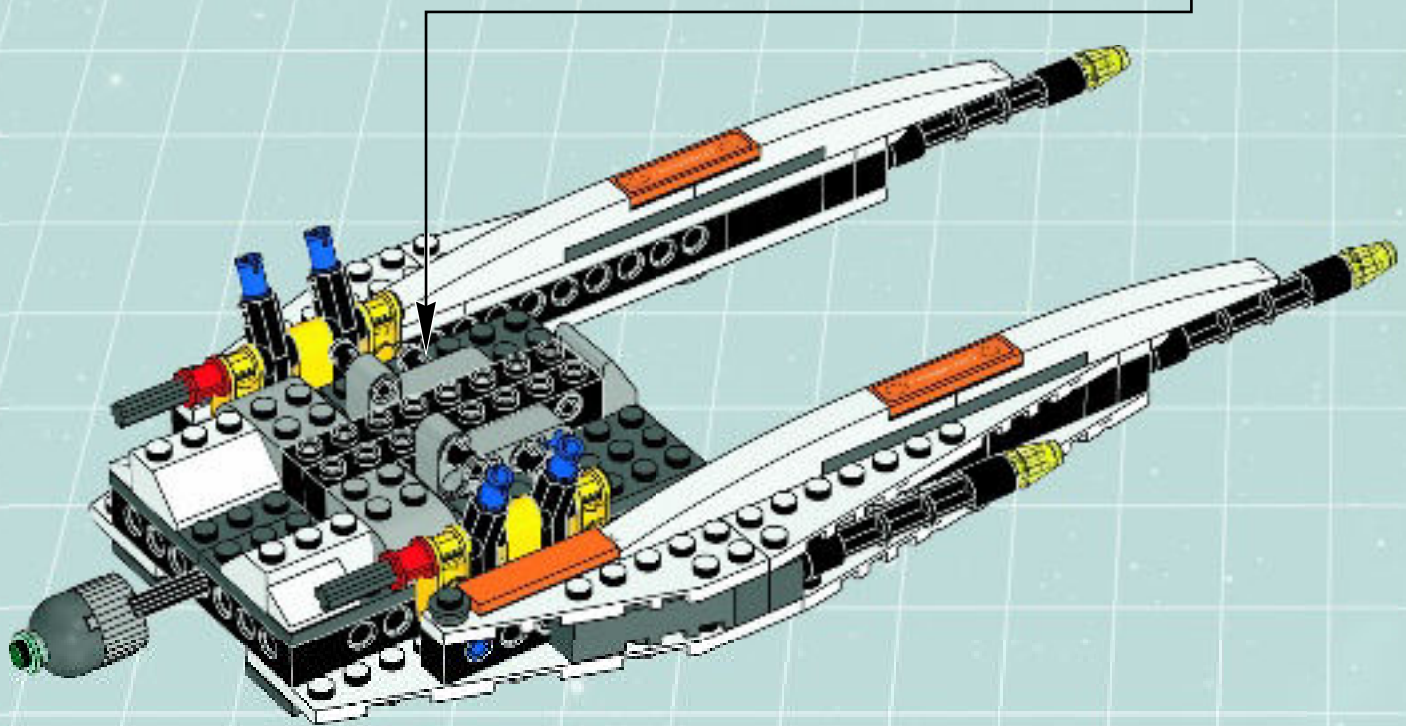
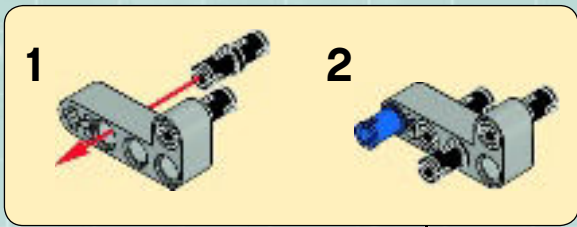
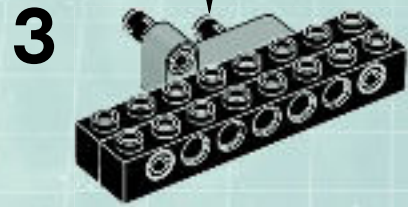
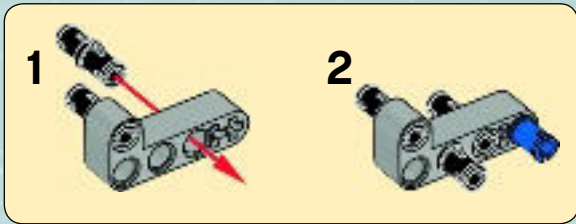

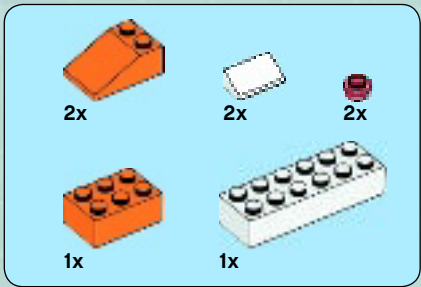

24

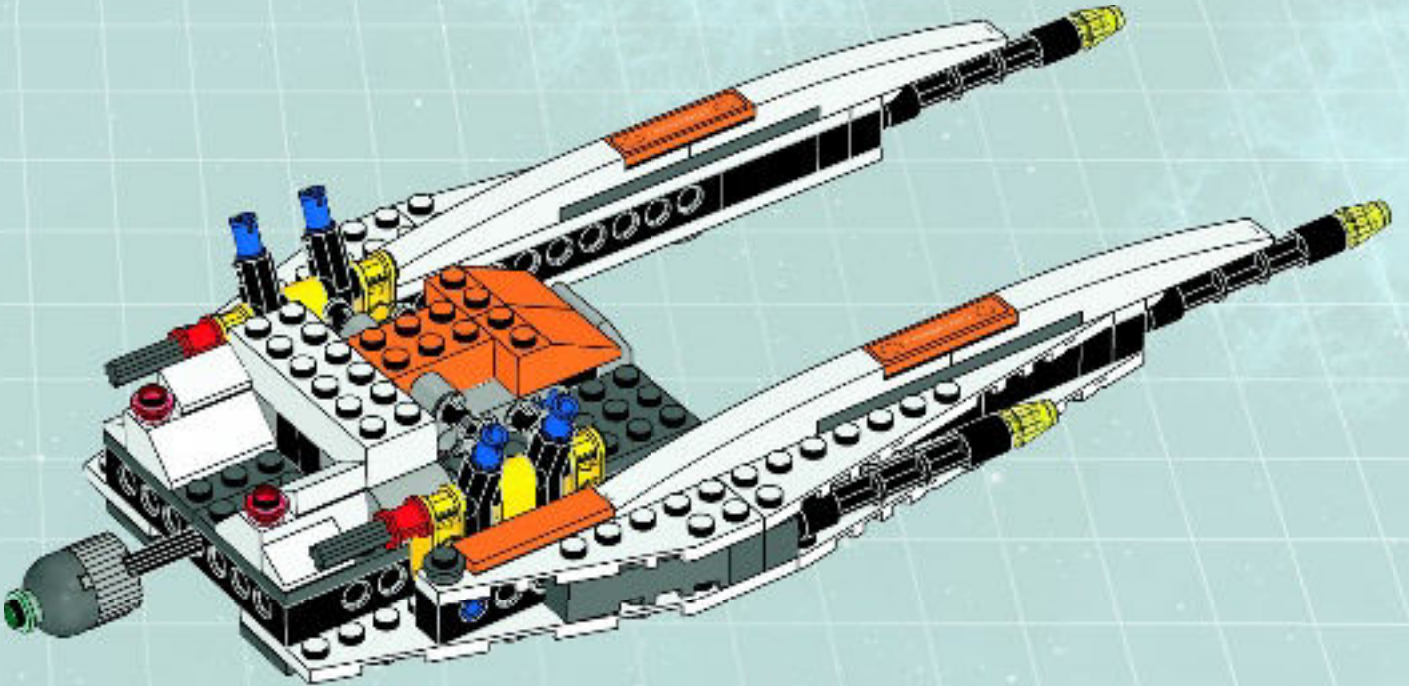

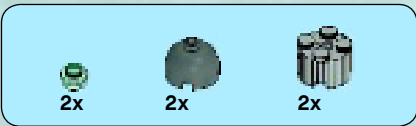

25

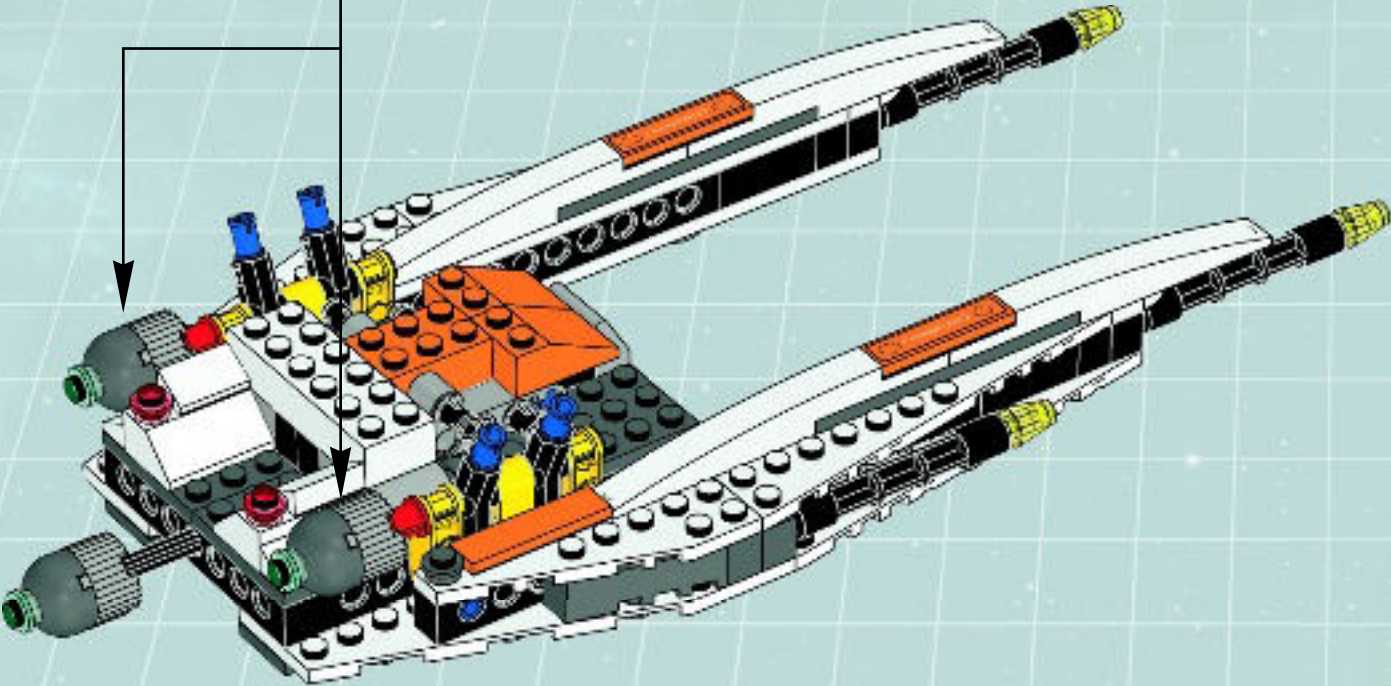
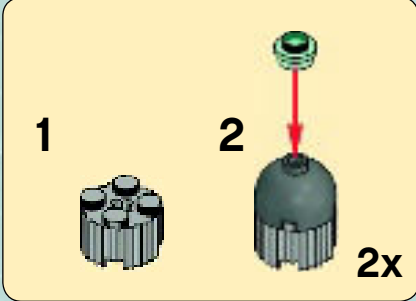

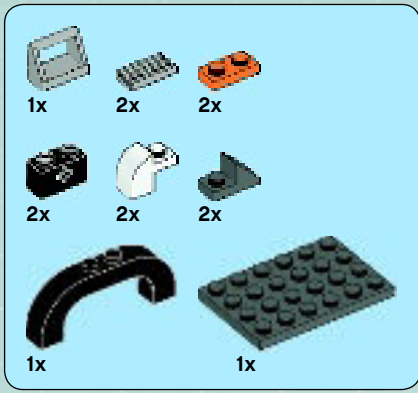

26

1



2



3



4



5

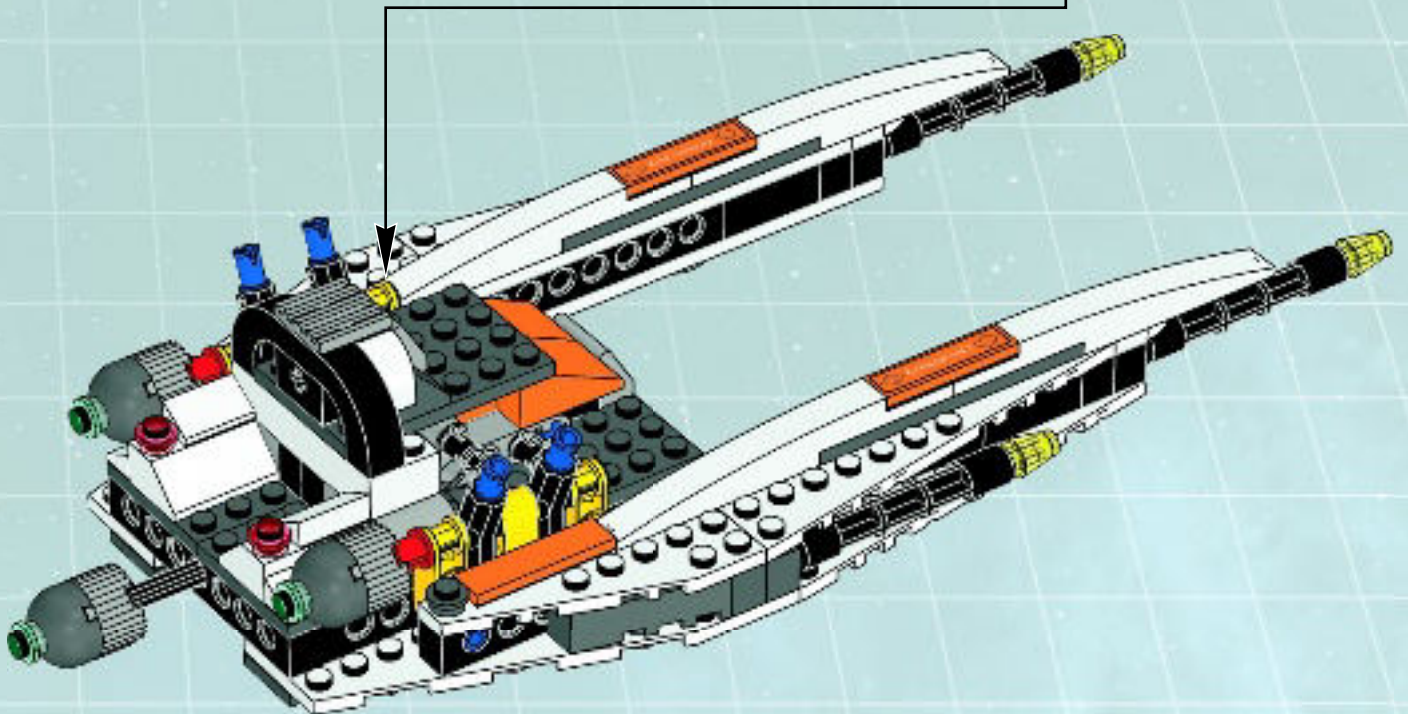

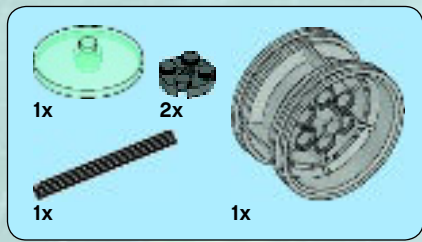

27

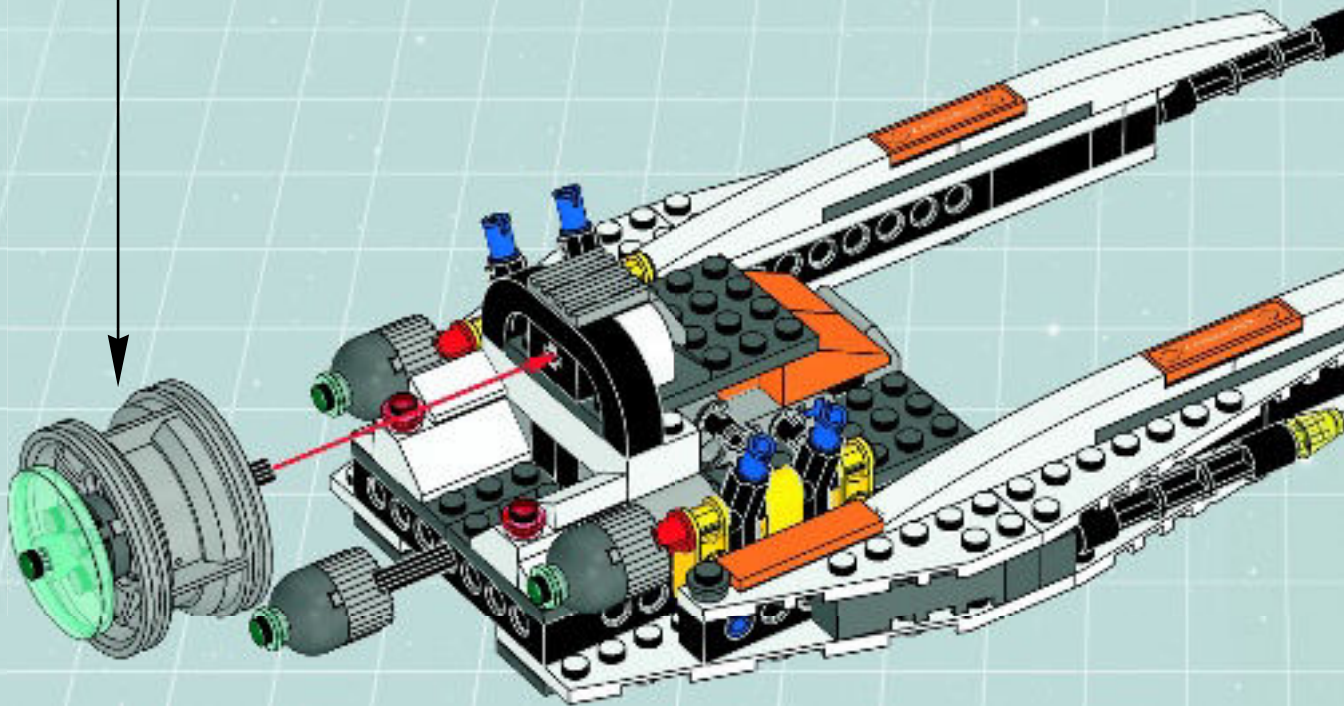
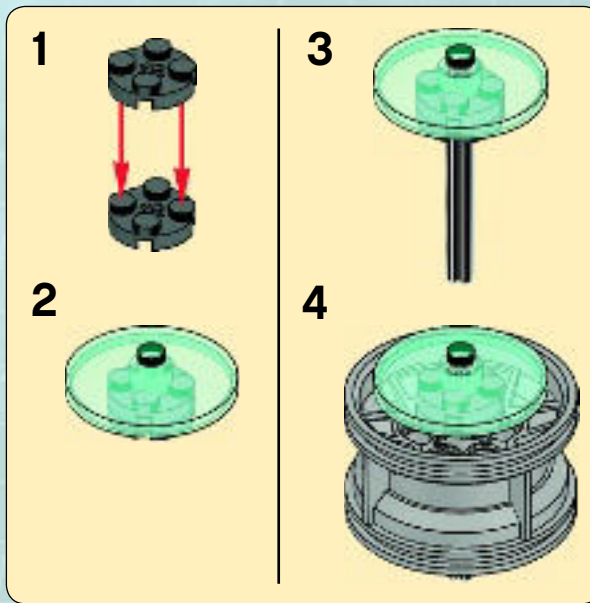

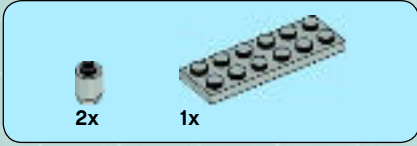

1

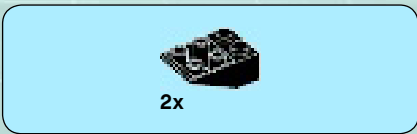
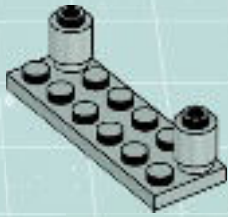

2

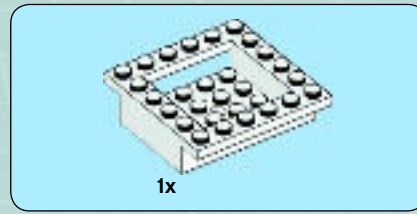

3

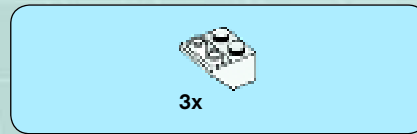
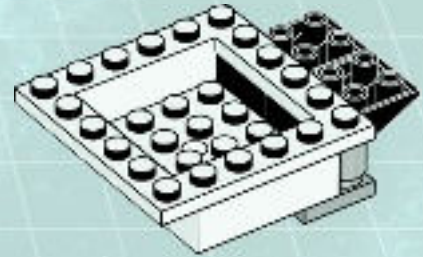

4

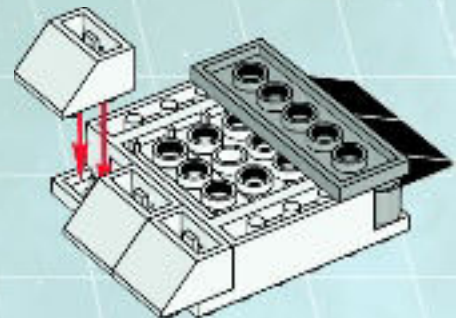
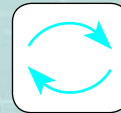



1x

5

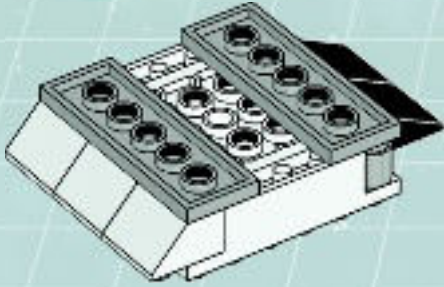

3x



1x



1x

7

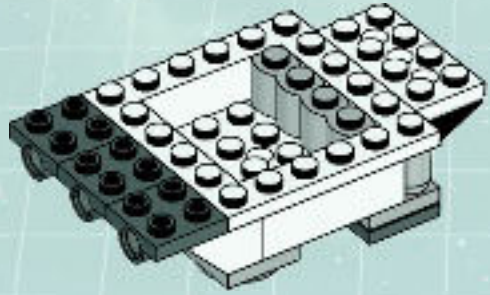
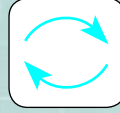

2x



2x

6

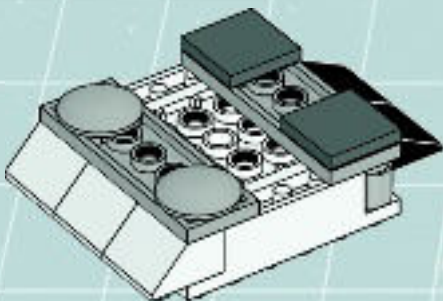

1x



2x



1x



2x

8



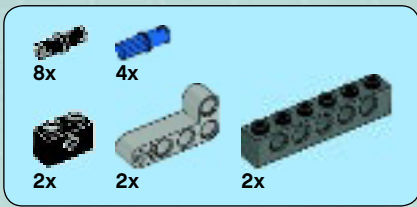

9

1

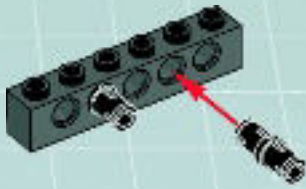

2



3

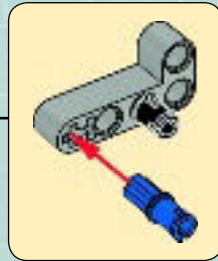
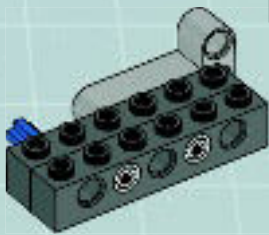

4



5

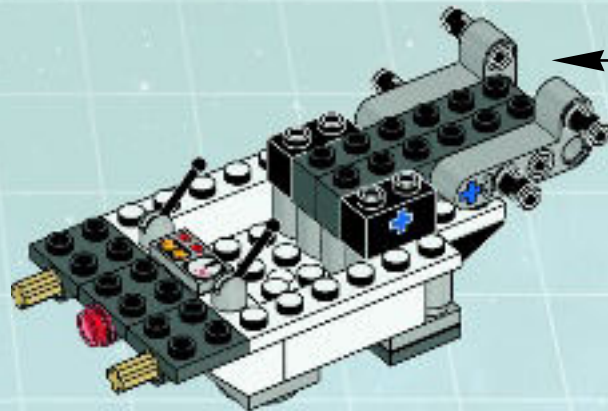
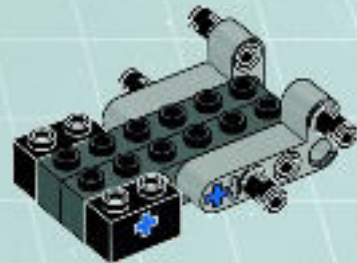

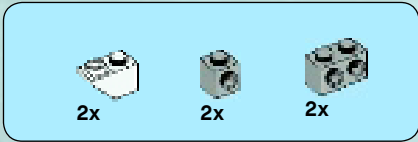

10

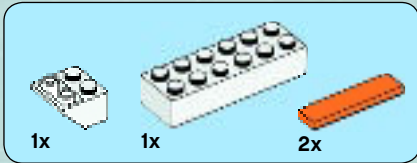
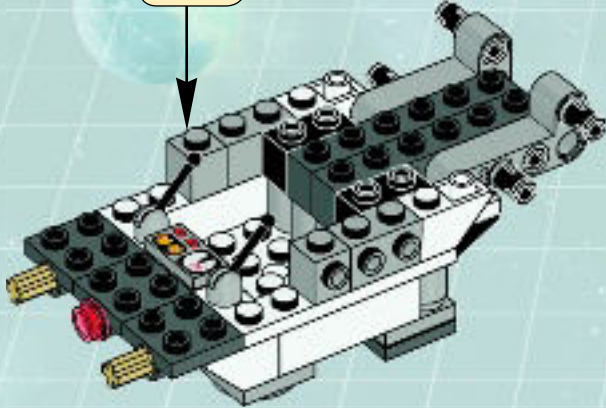

12

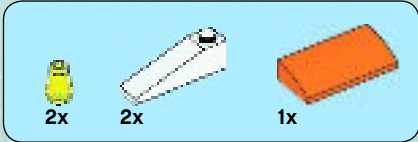
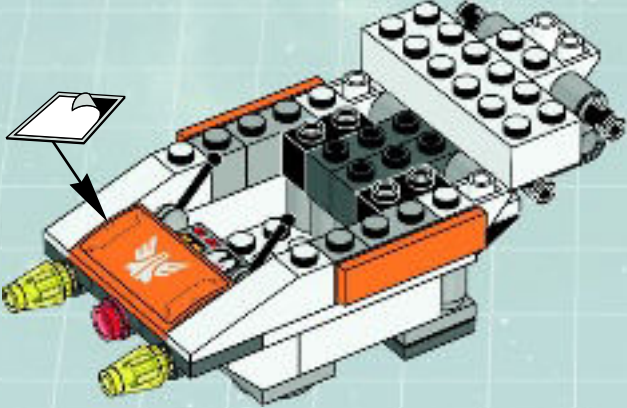

11

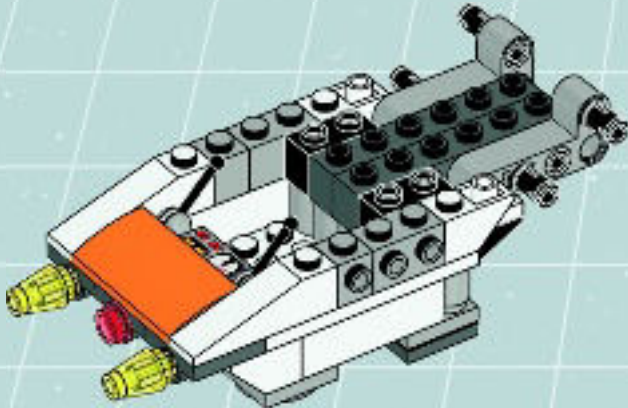

13

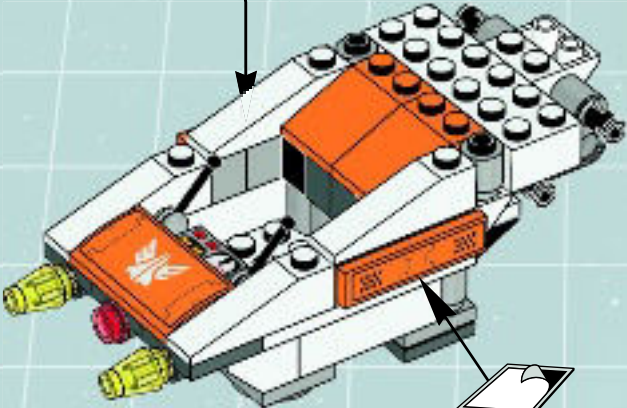

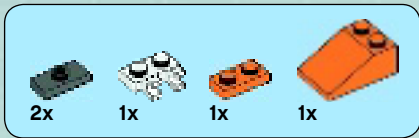

14

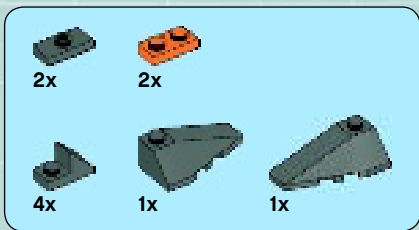
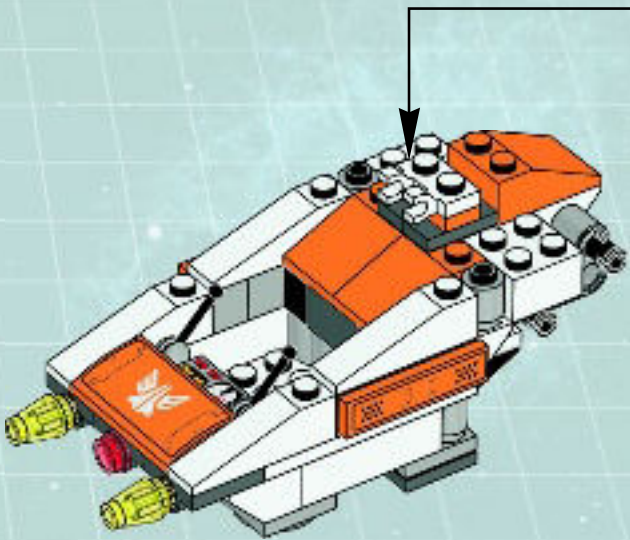

15

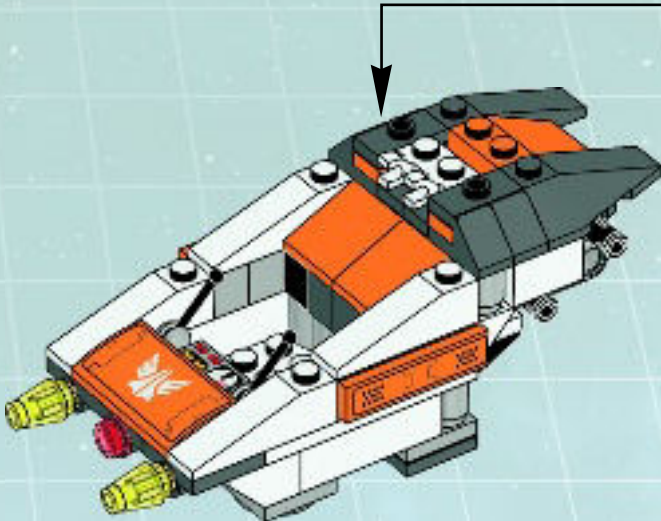

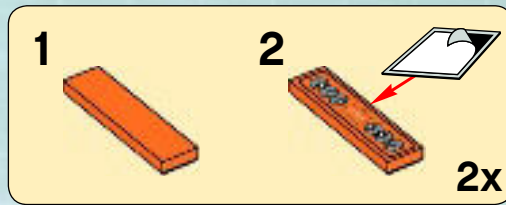
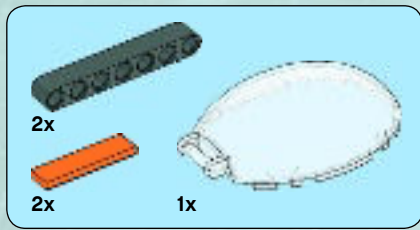

16

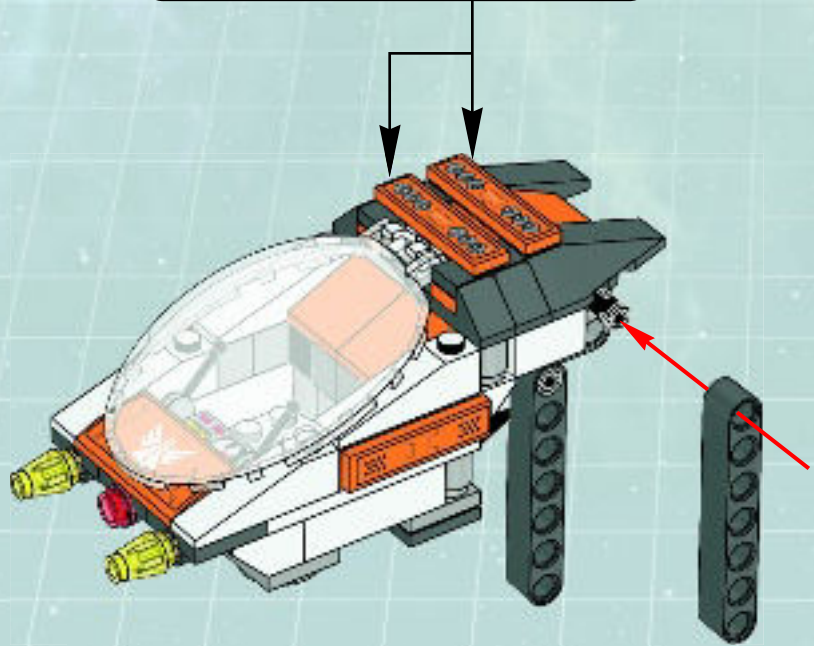

28

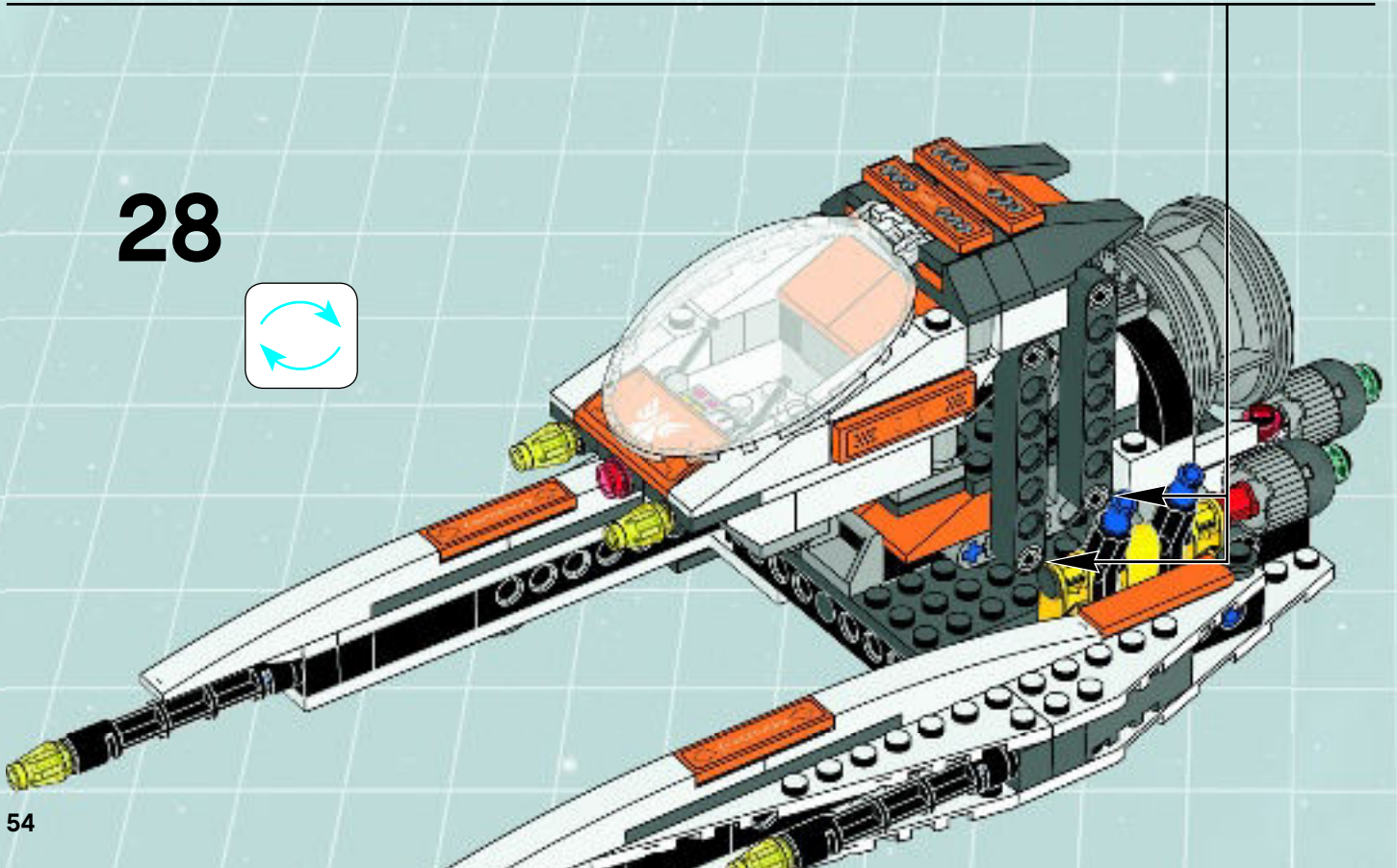
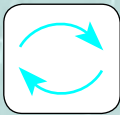

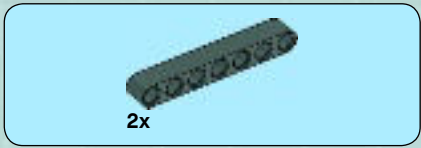

29

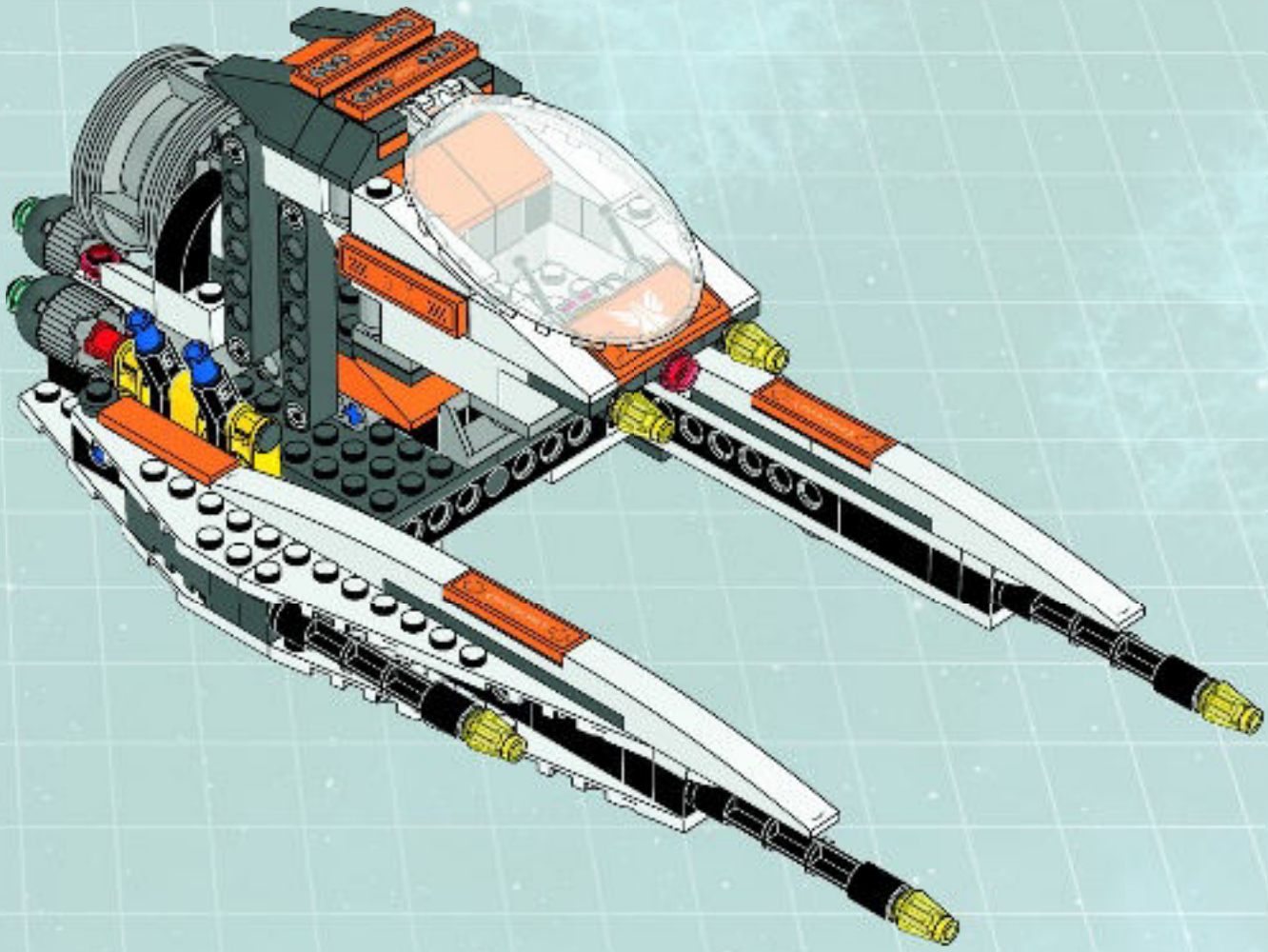



30

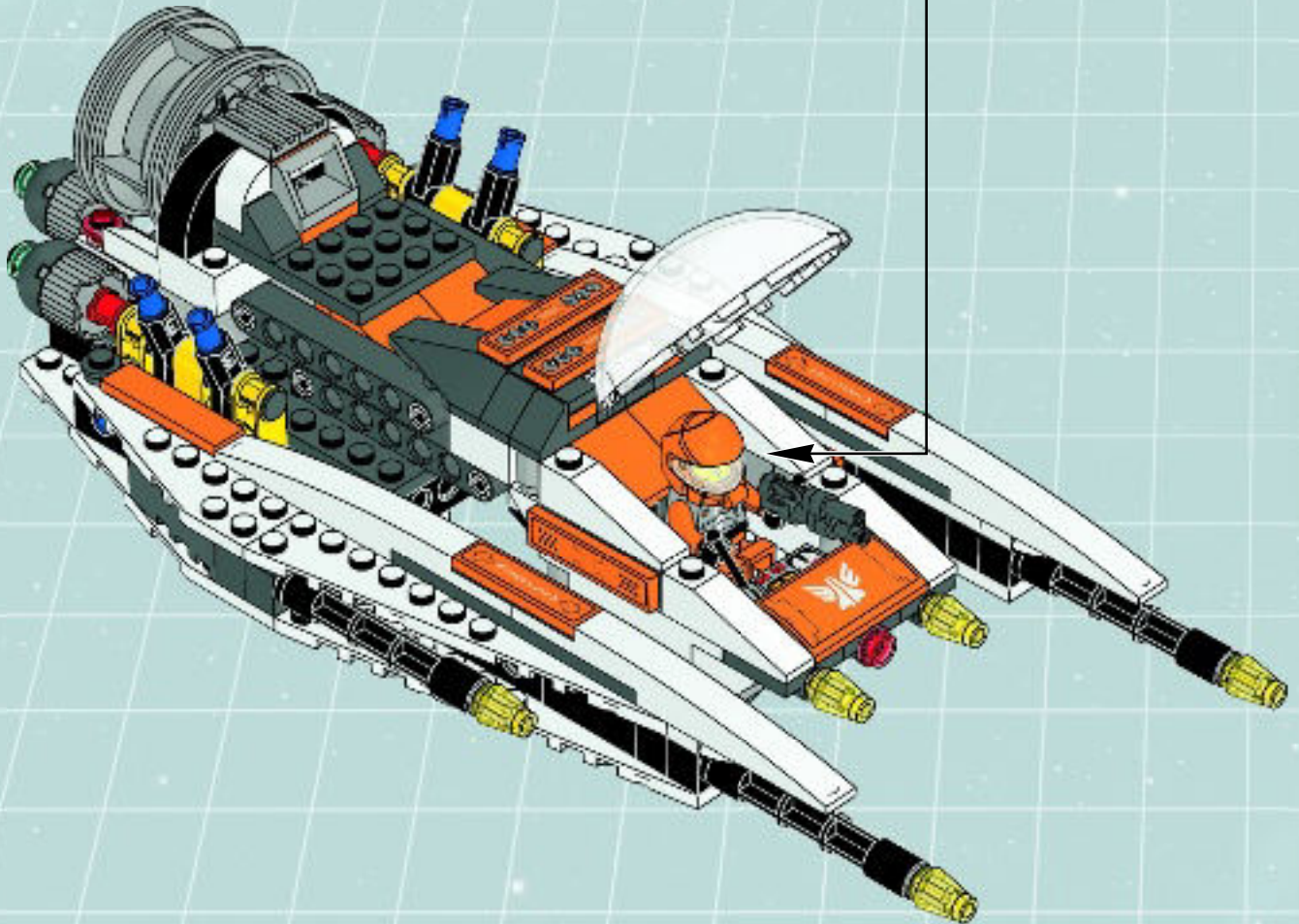
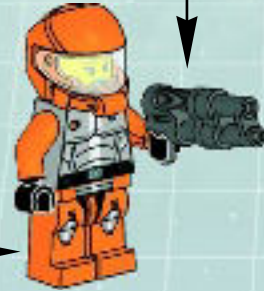
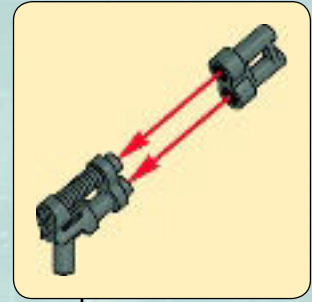
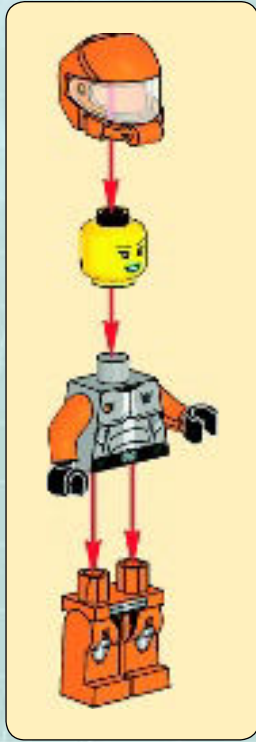

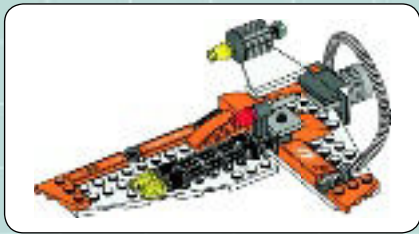
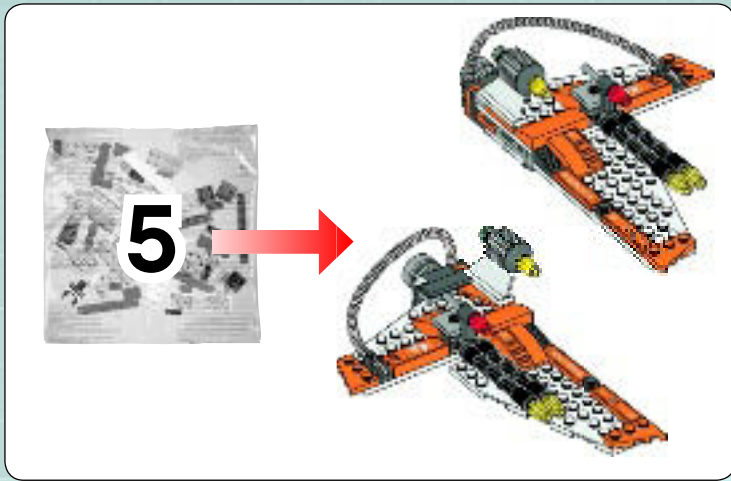

1

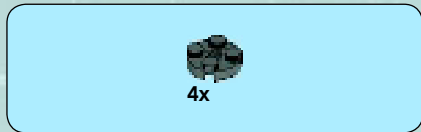

2



3

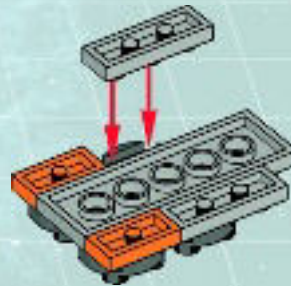
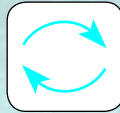

4

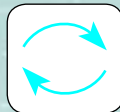

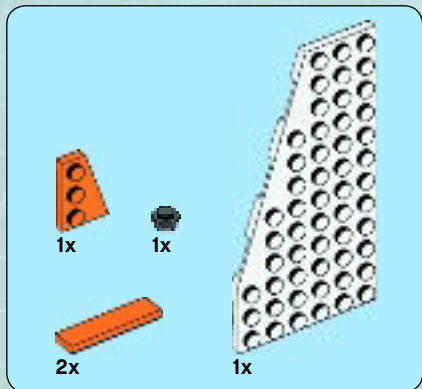

5

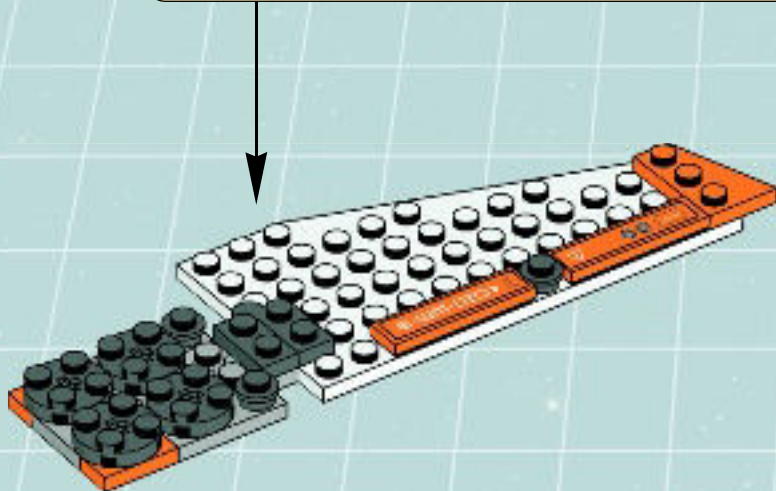
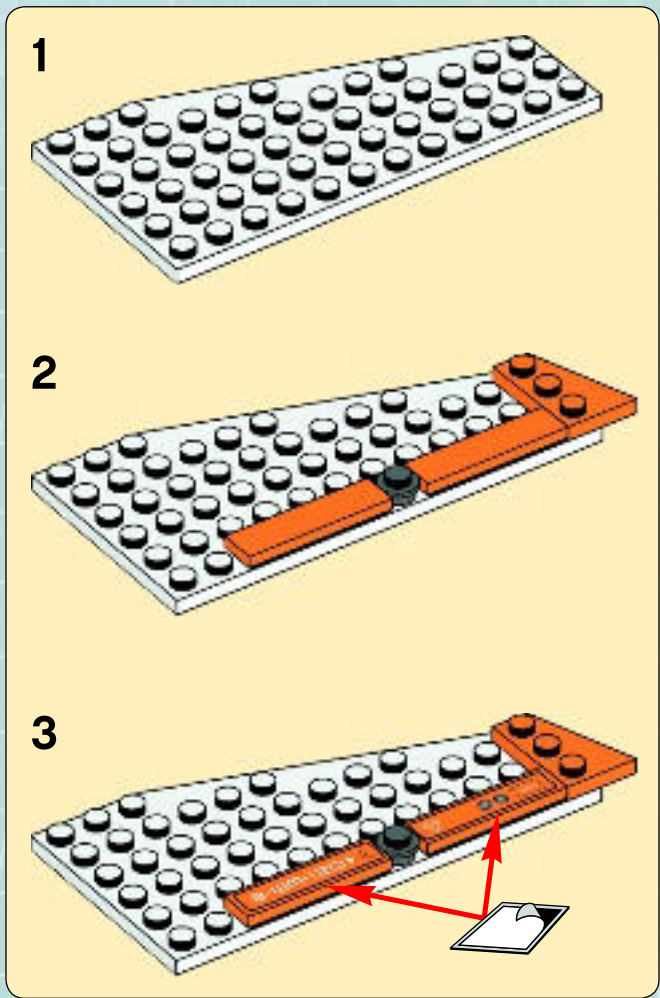



6

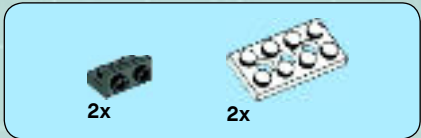
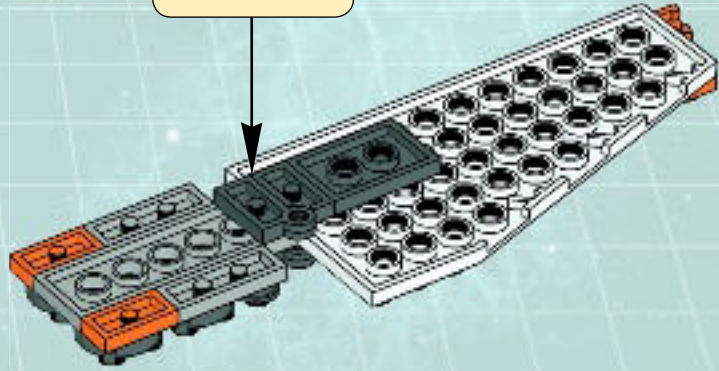
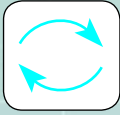

7

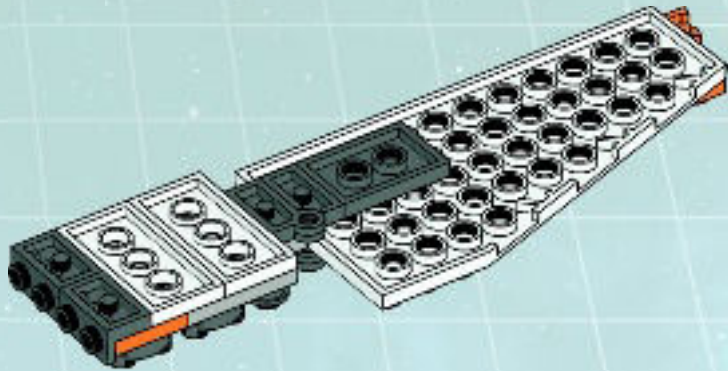



8

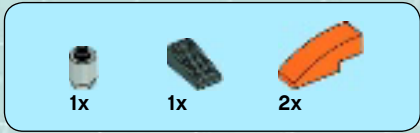
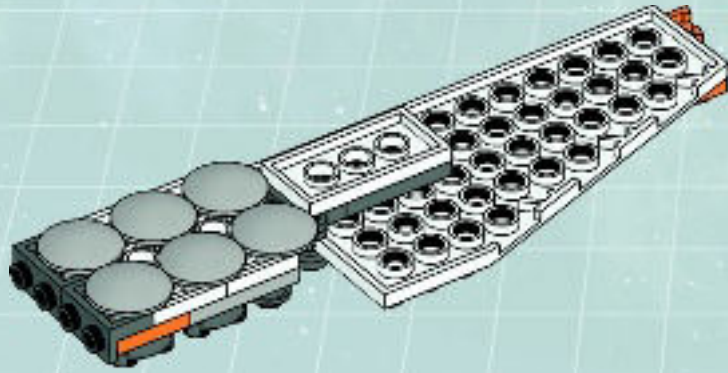

9

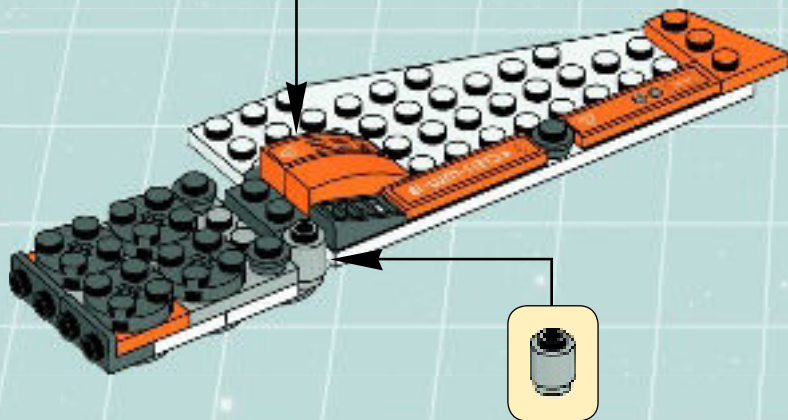
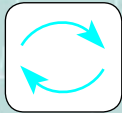
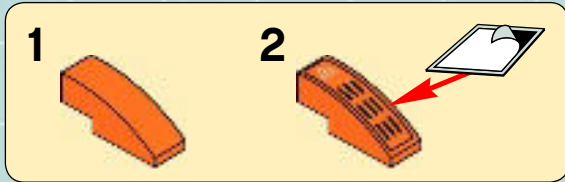

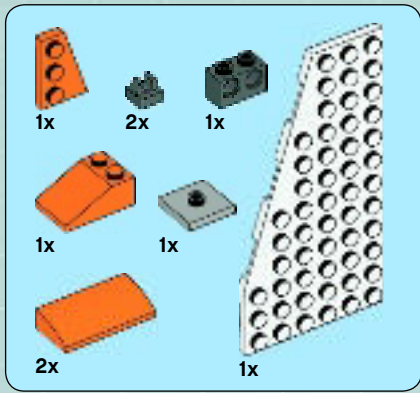

10

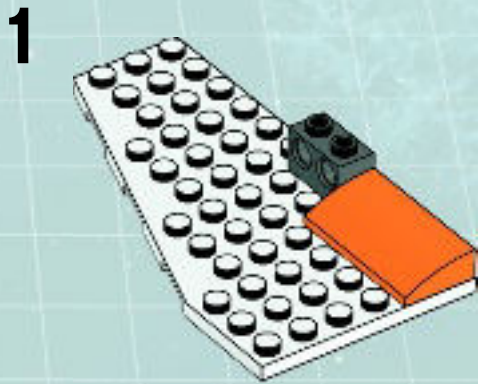

2

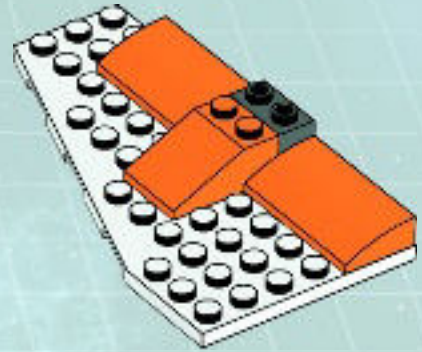

3

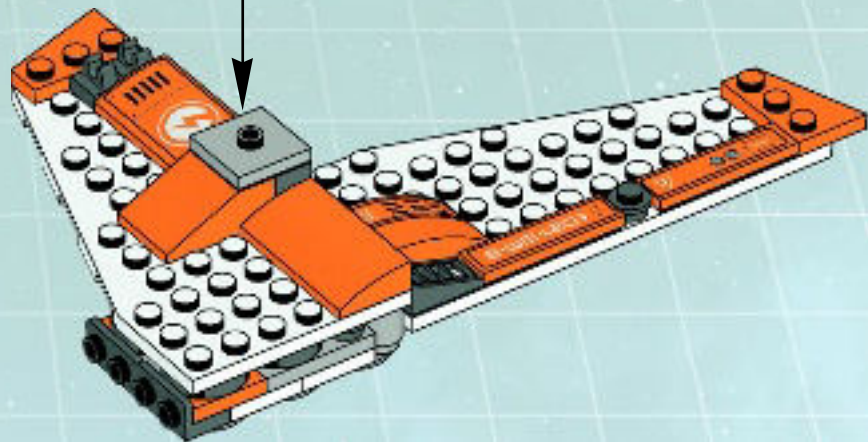
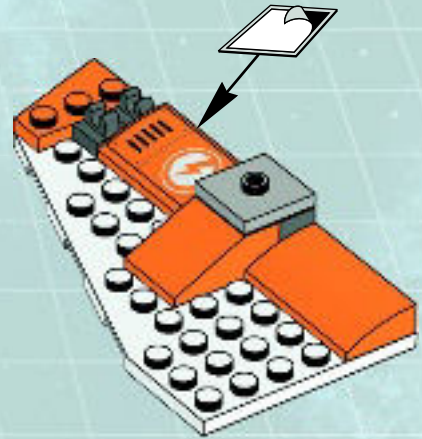

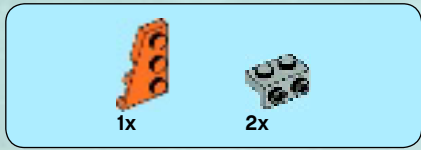

11

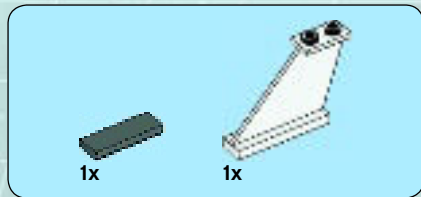
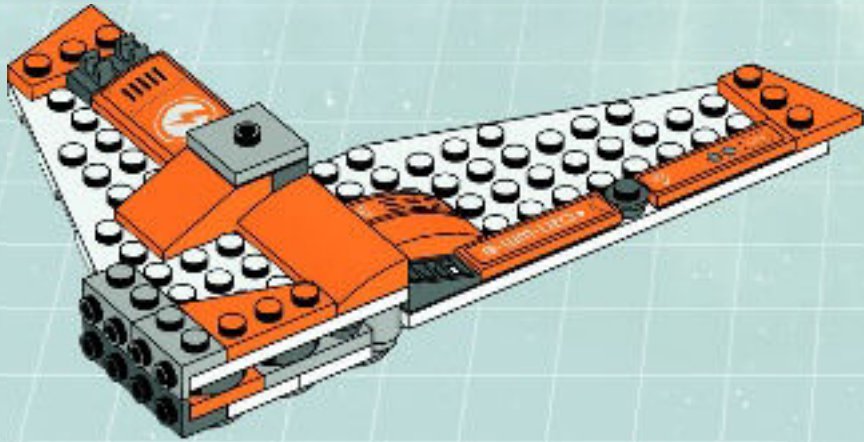

12

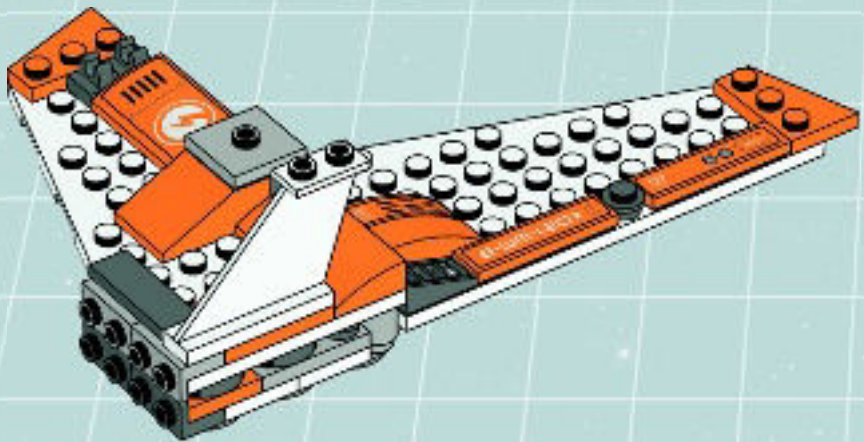



13

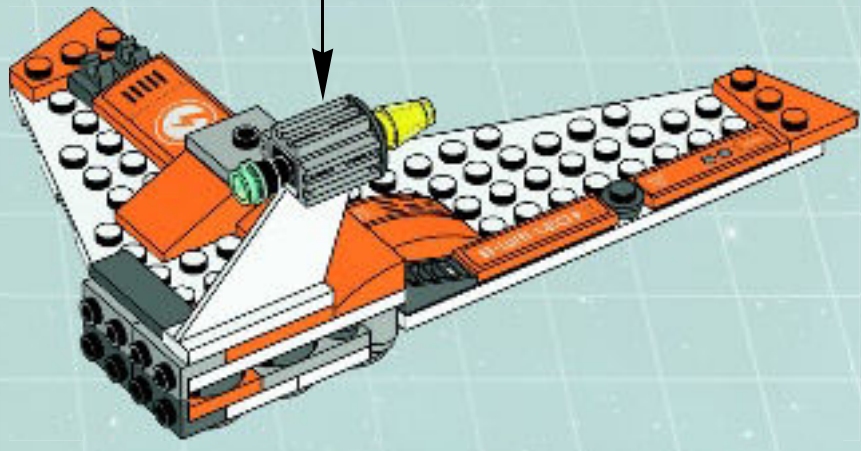
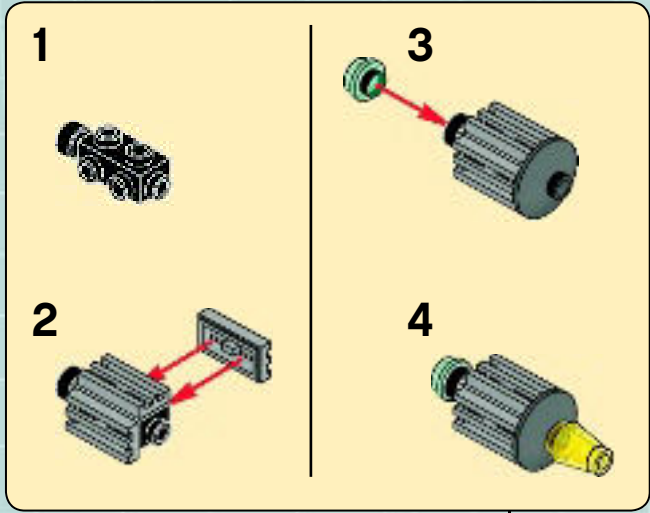

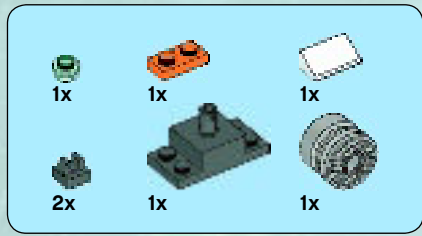

14

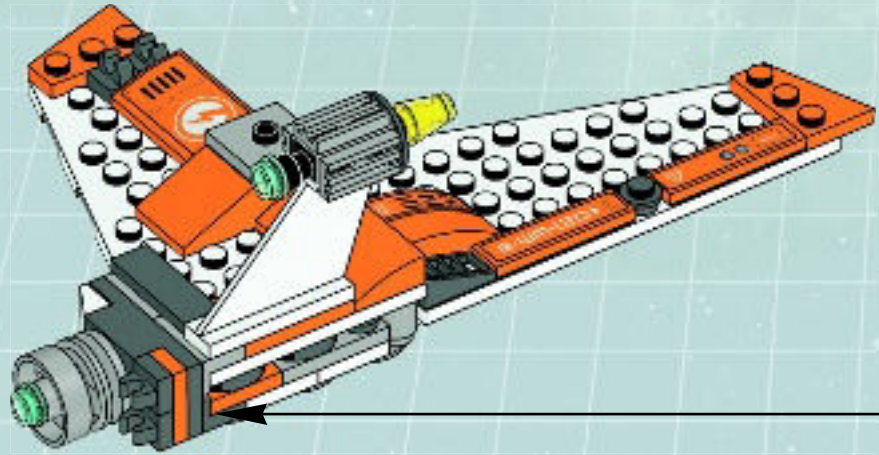
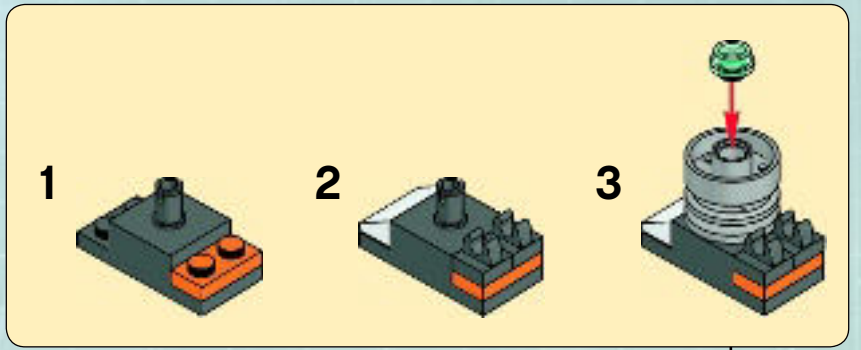

15

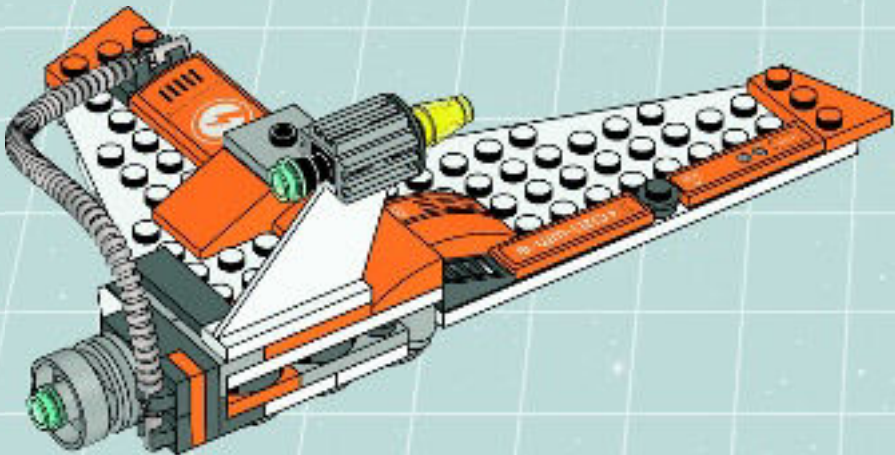

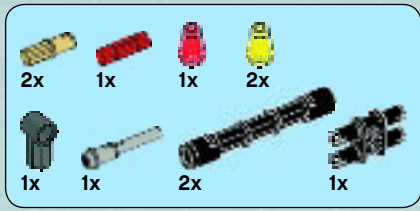

16

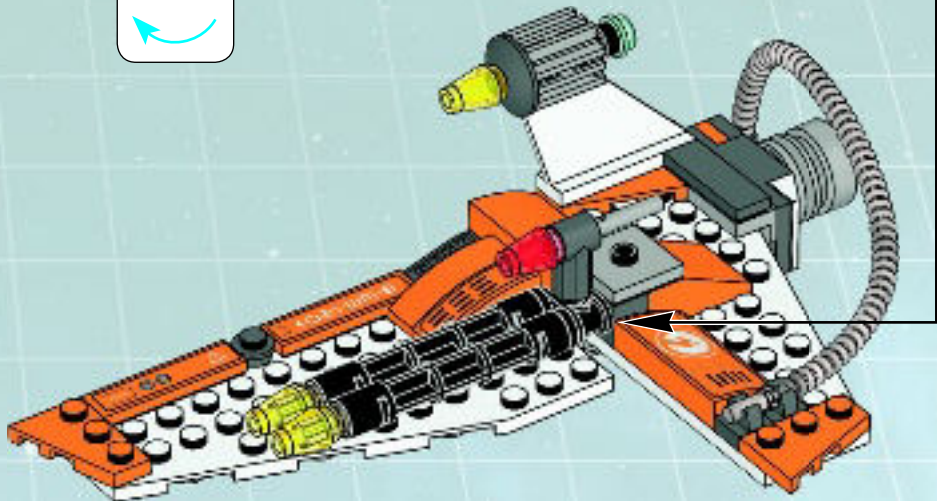
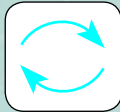
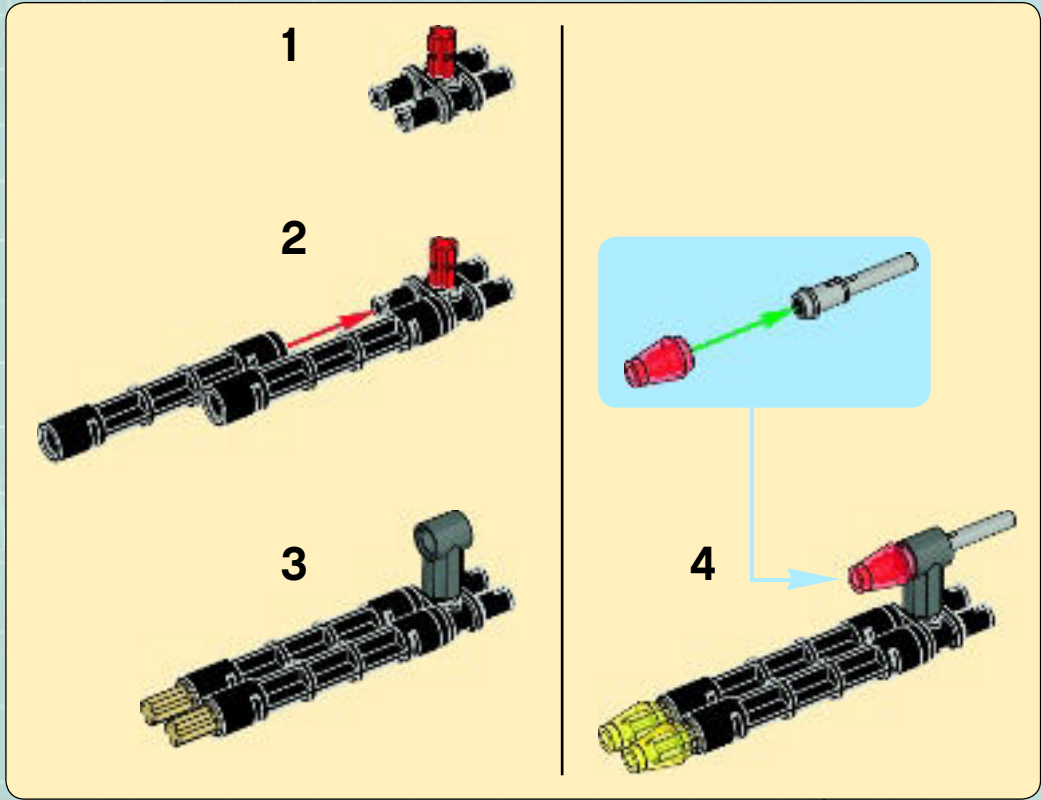

31

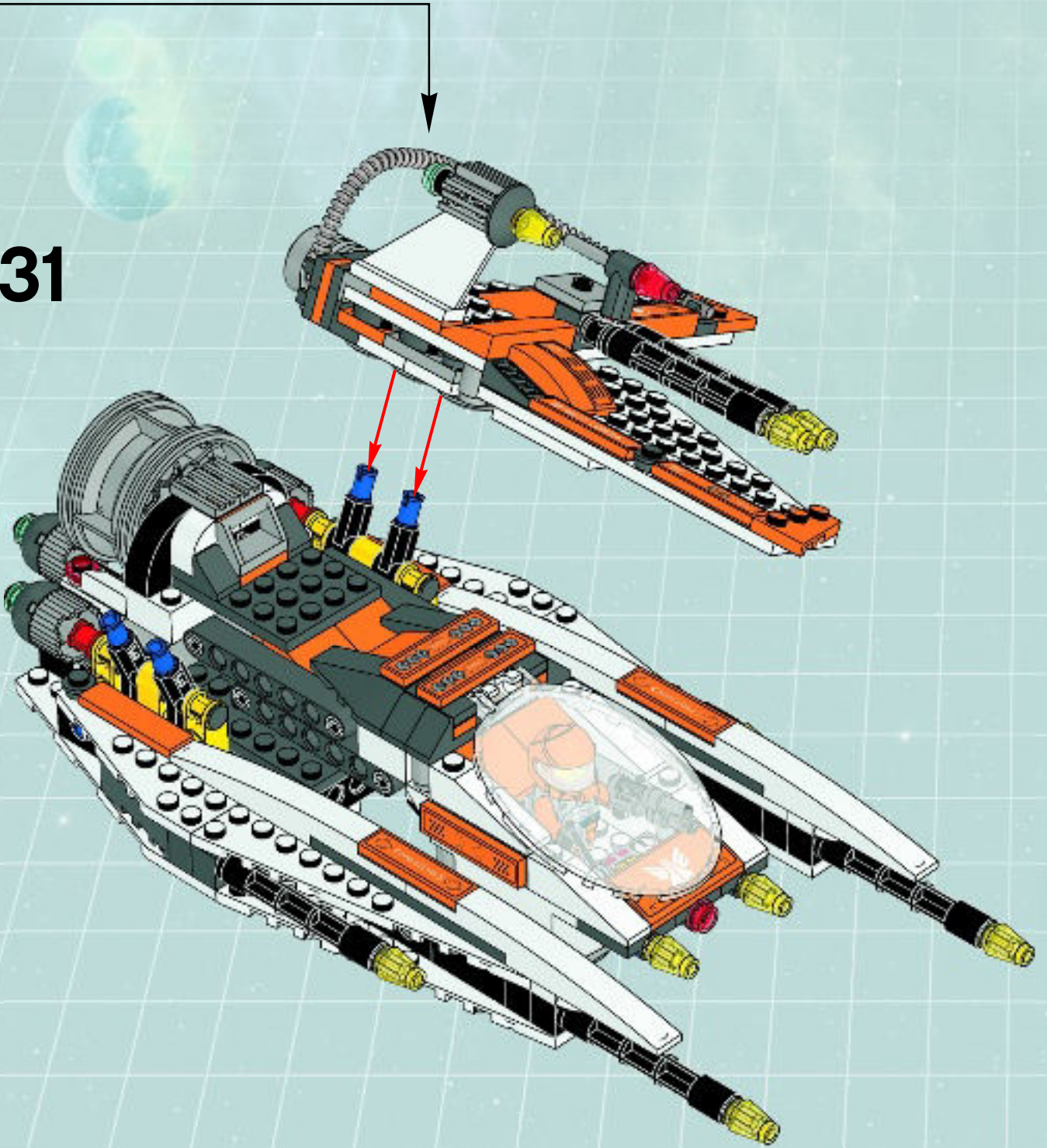



1x

1

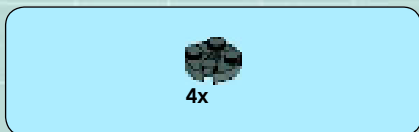

4x

2

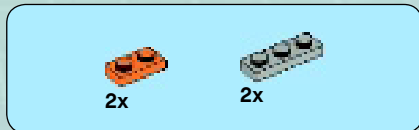

2x

2x

3

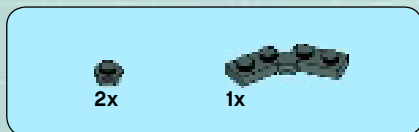
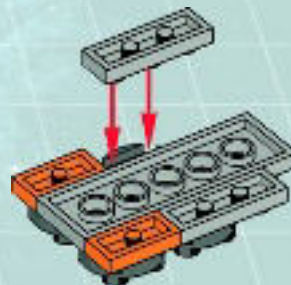
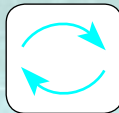

2x

1x

4

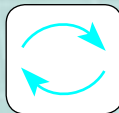



6

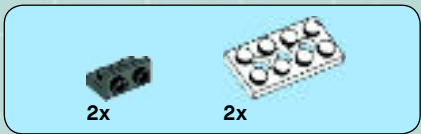
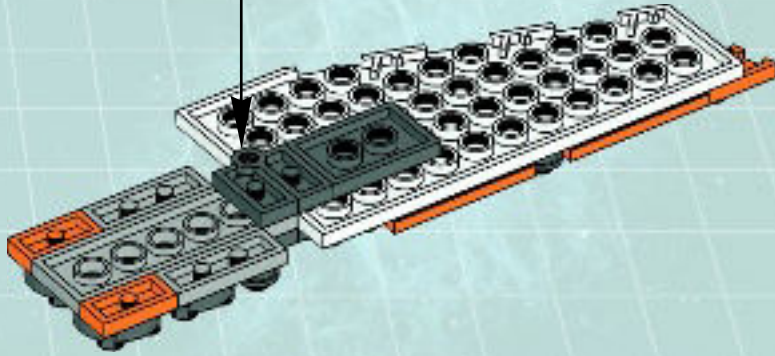

7

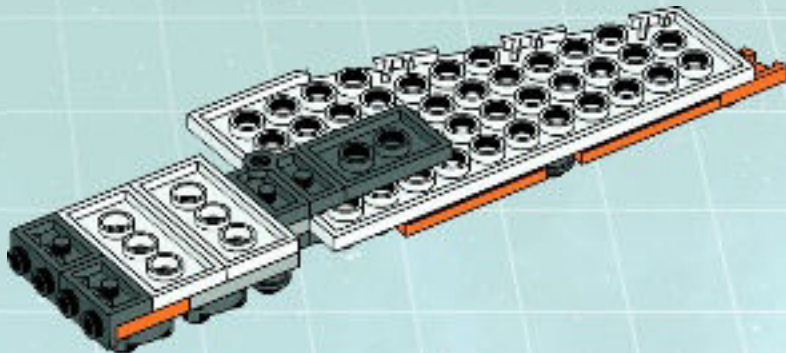

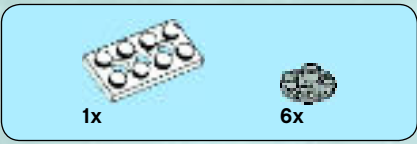

8

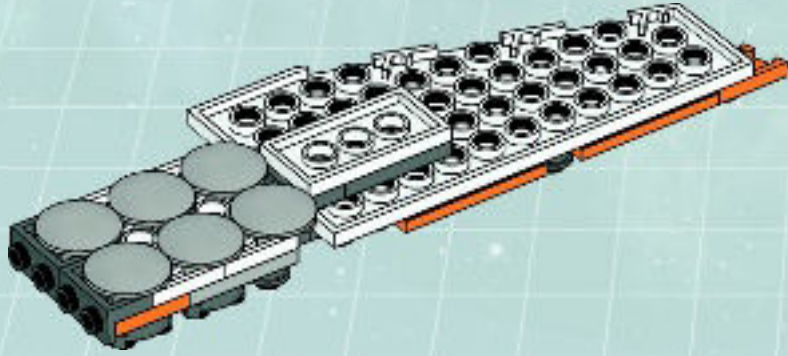

9

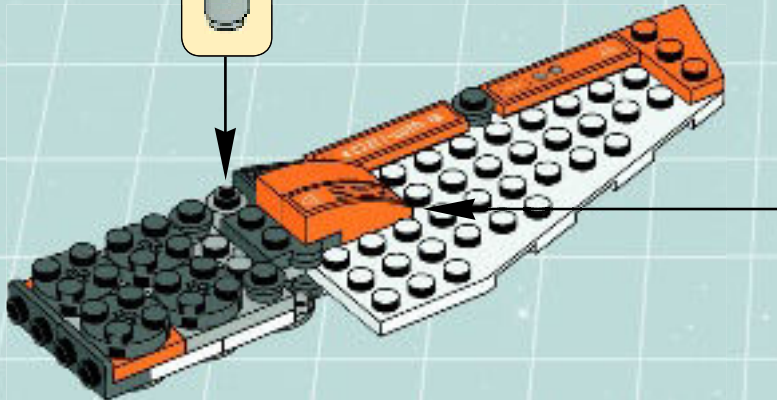
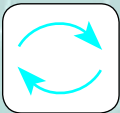

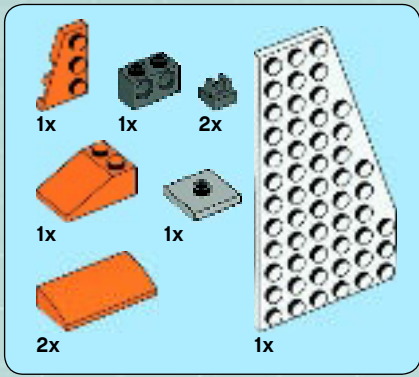

10

1

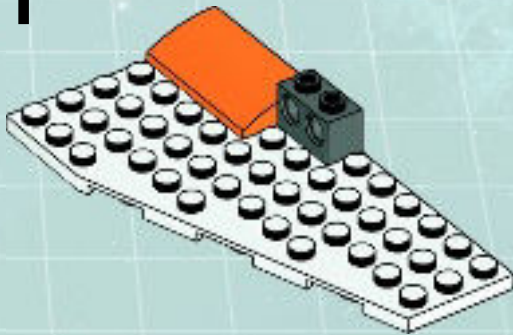

2

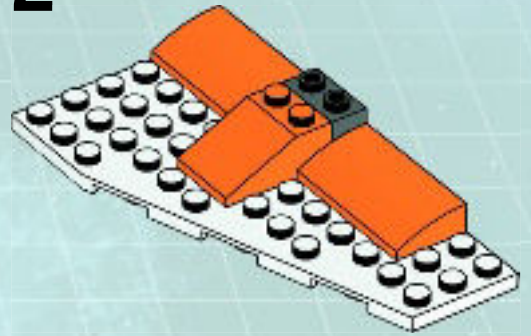

3

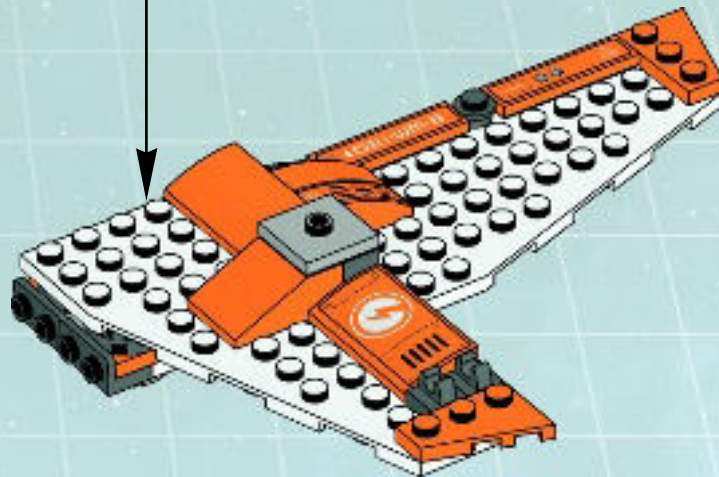
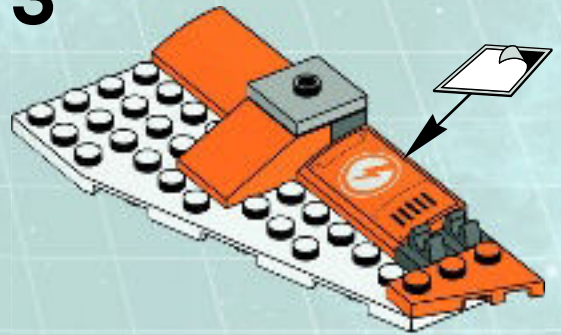



11

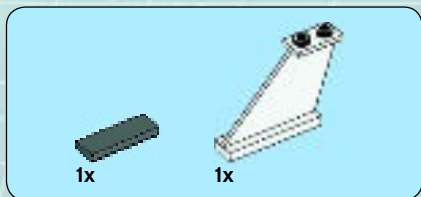
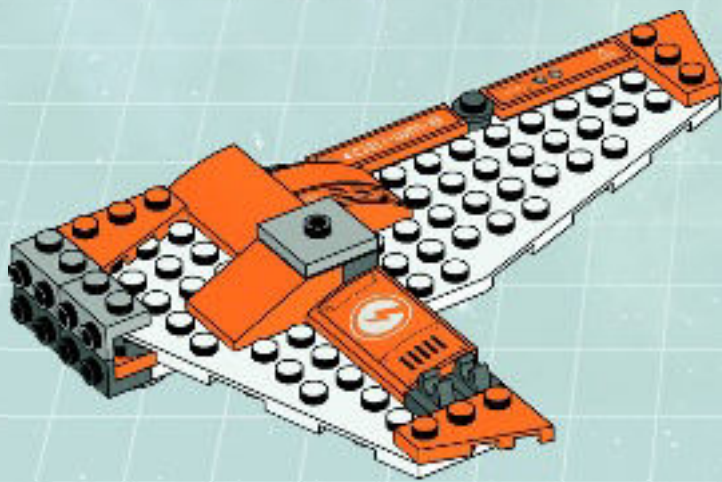

12

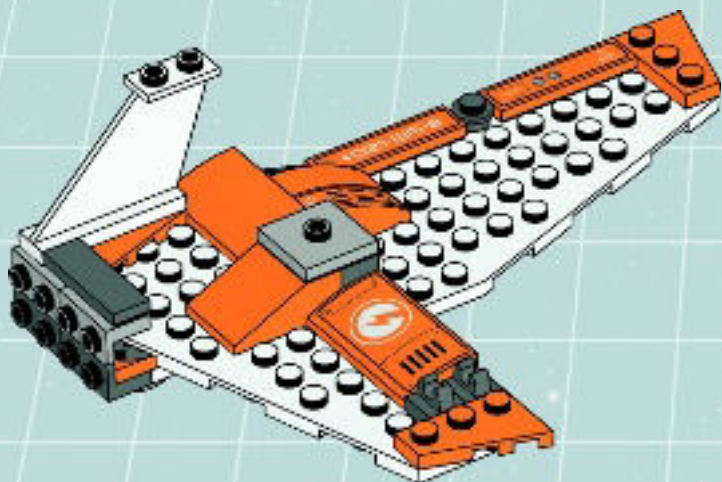



13

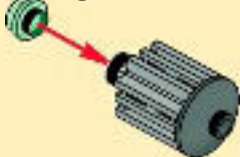
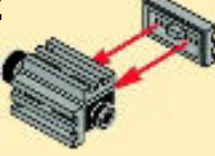
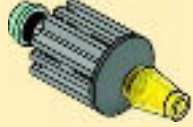

<p>1</p> 	<p>3</p> 
<p>2</p> 	<p>4</p> 

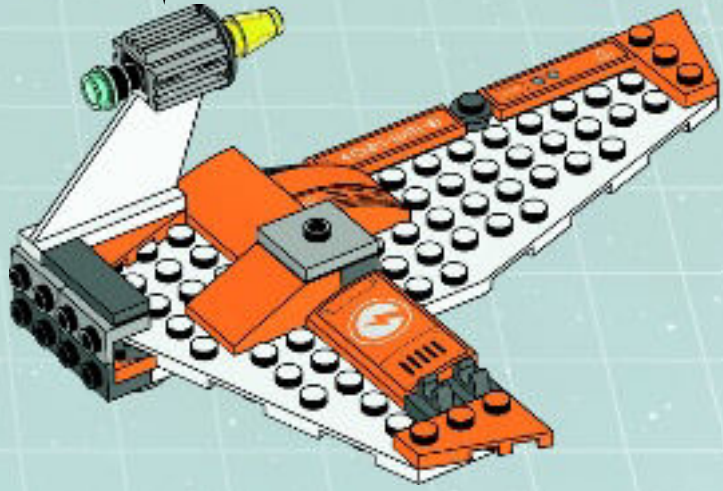



14

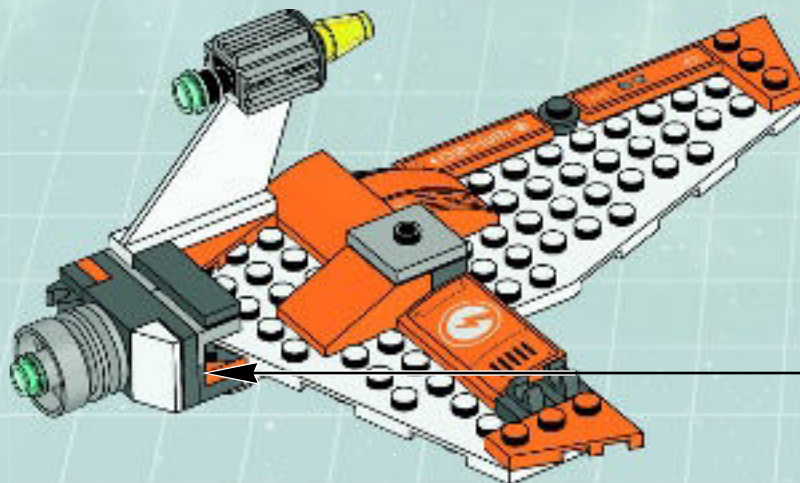

15

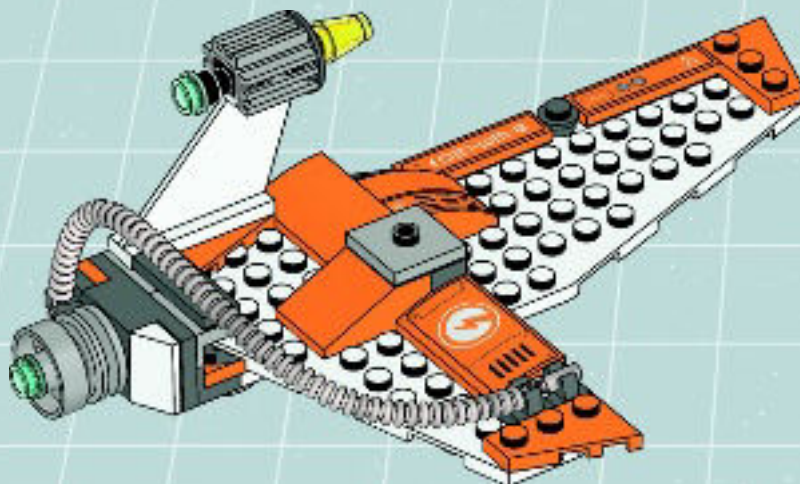

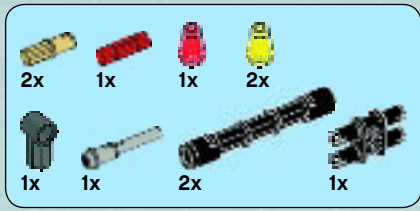

16

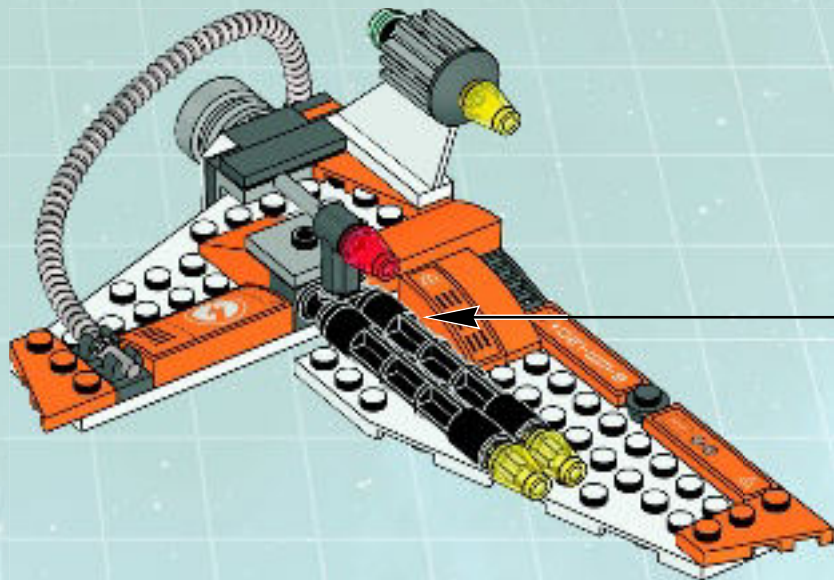
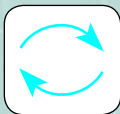
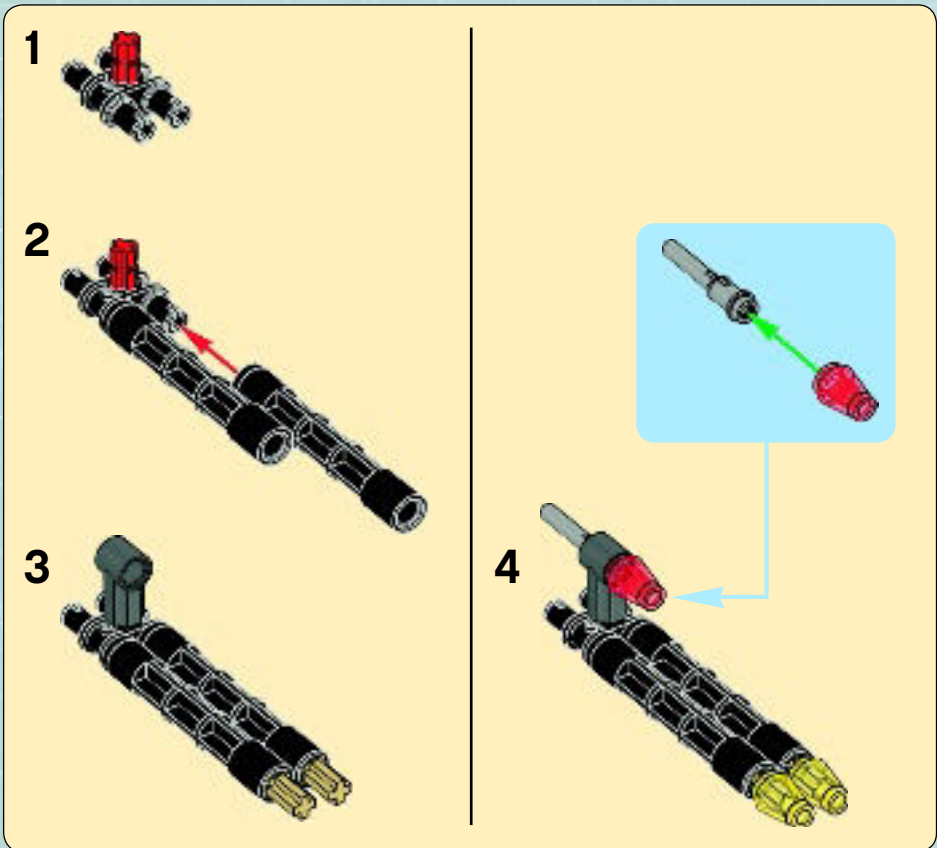

32

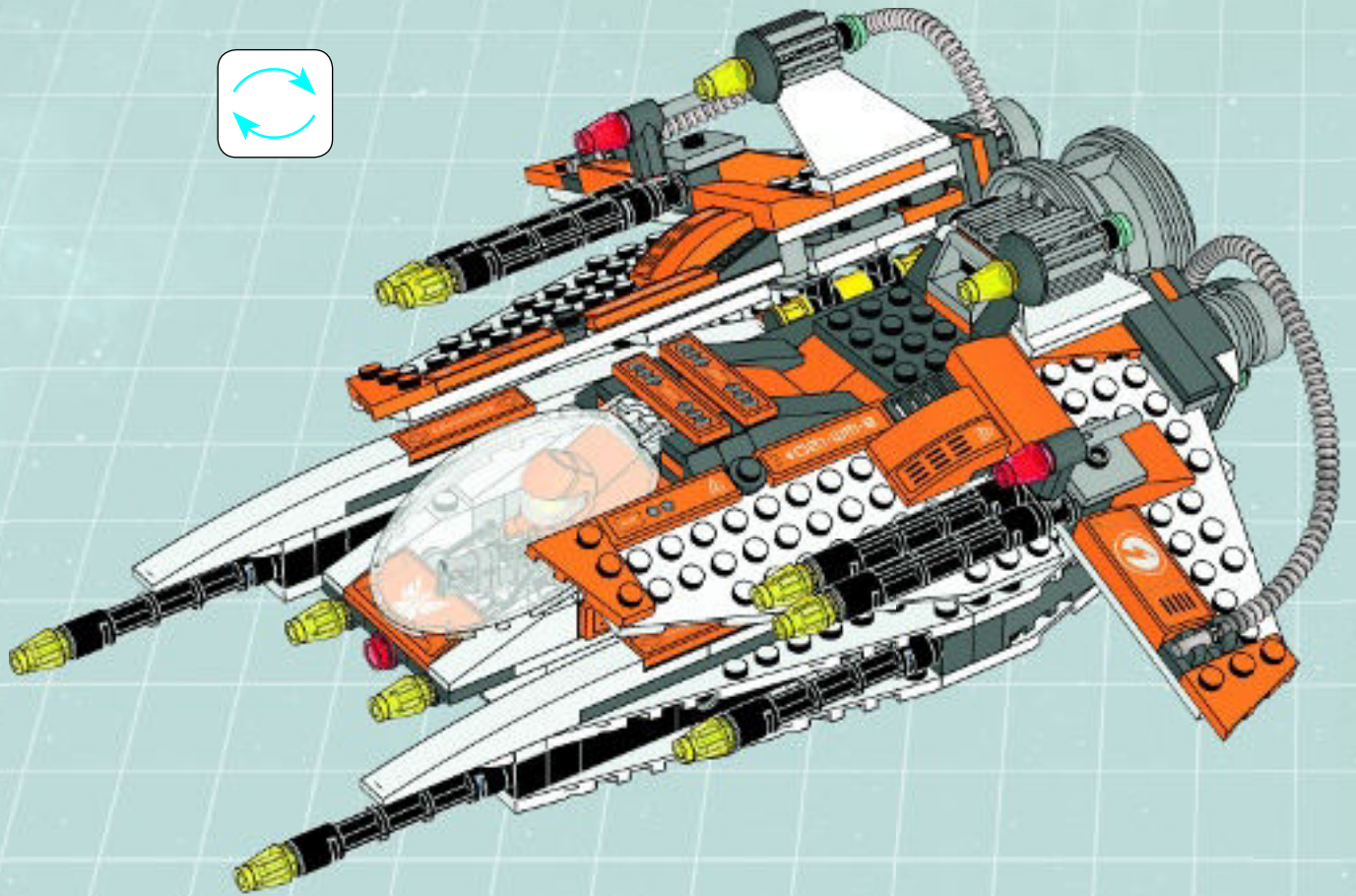
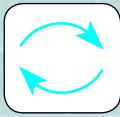

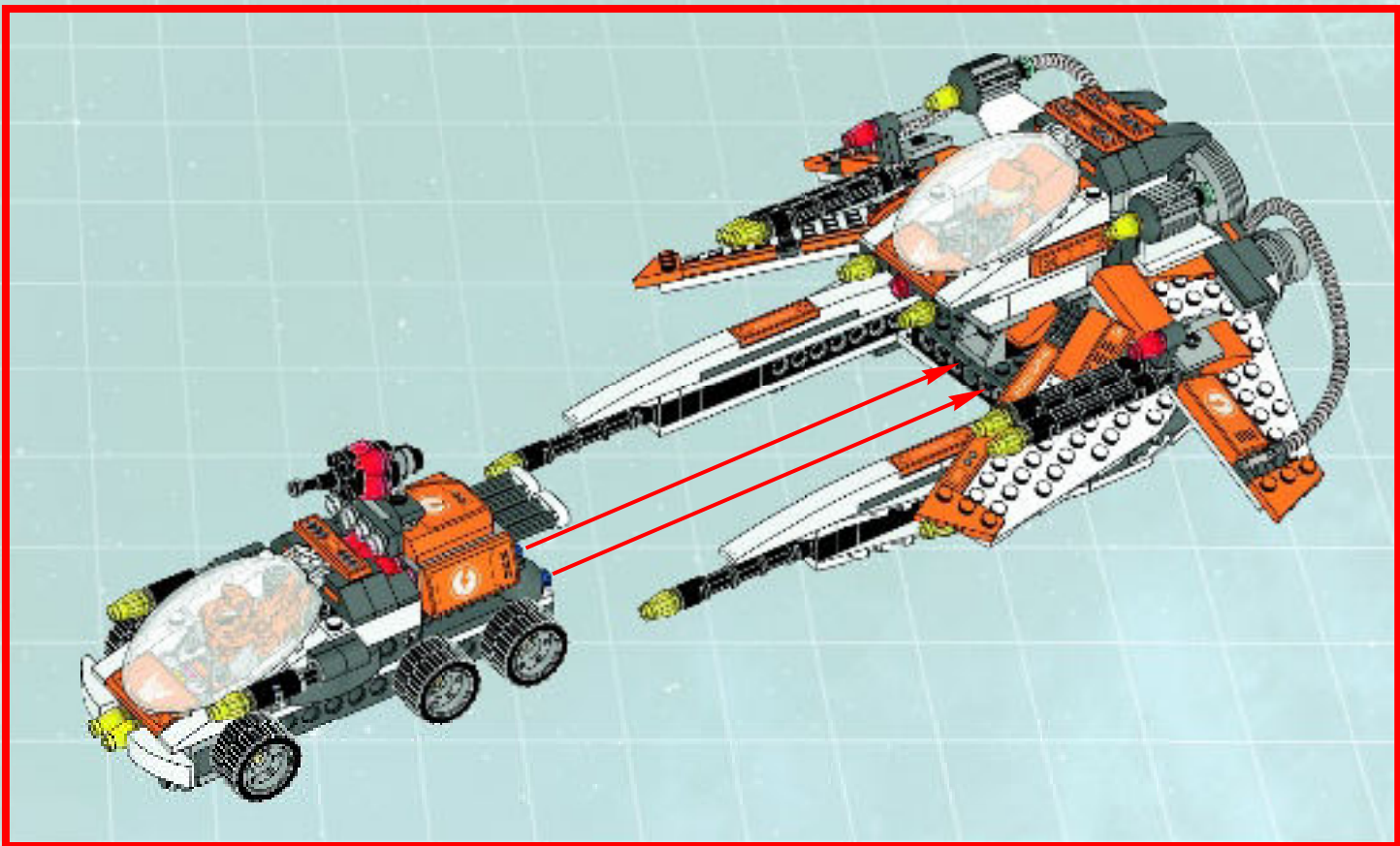
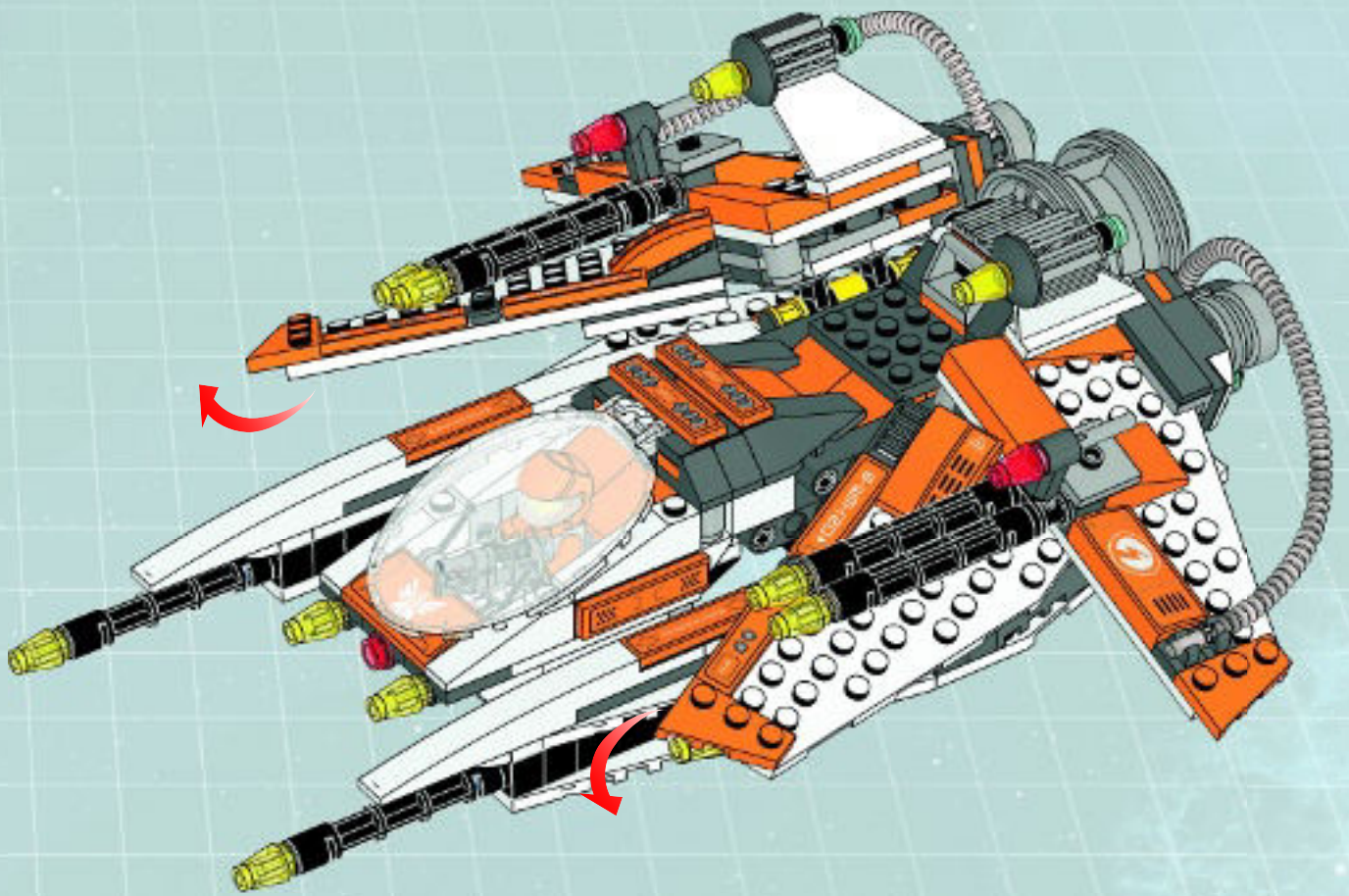

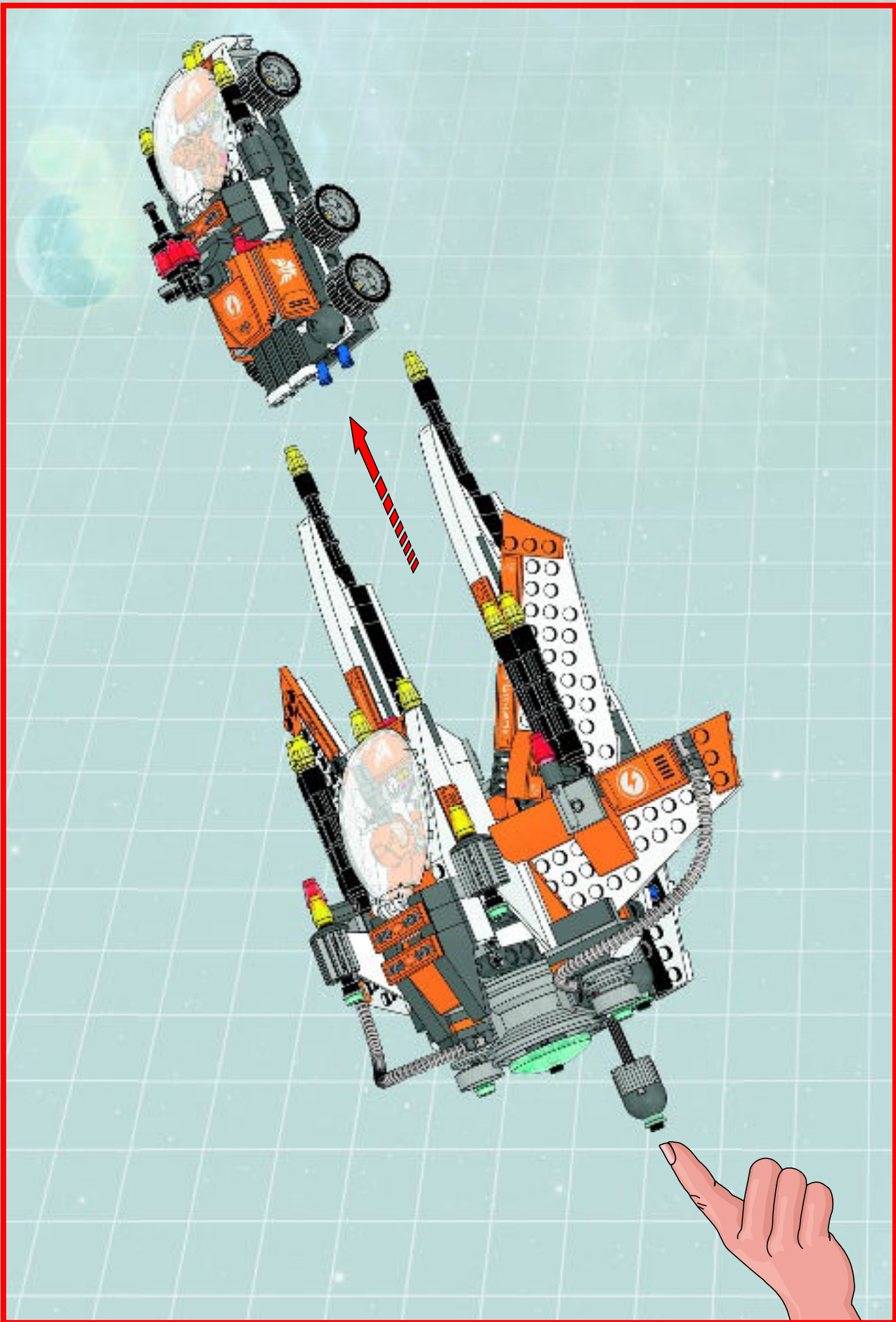

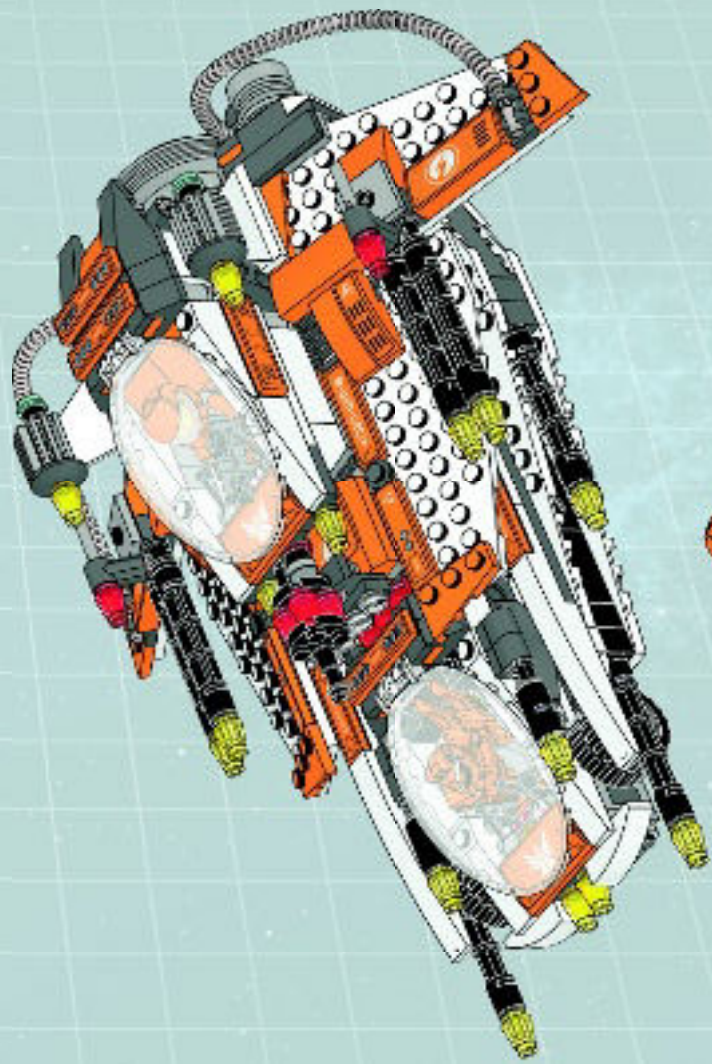



4x
362201

2x
4181142

2x
6023941

2x
370101

6x
4547489

2x
366501

1x
6032098

12x
366001

2x
4258358

8x
4515359

2x
609101

2x
4249112

4x
4547368

1x
366601

2x
303401

3x
4556152

2x
4208987

1x
4256095

1x
4256097

2x
4209005

3x
4141476

3x
4141475

2x
234001

2x
4224792

2x
4163533

8x
370901

18x
4666579

2x
4128598

2x
4227155

6x
4142865

1x
4513174

14x
4206482

10x
4514553

1x
6023888

1x
6028339

2x
4187122

4x
4175441

2x
235726

2x
362226

3x
4214559

4x
4233487

2x
4253815

2x
4523339

4x
654126

2x
4604304

2x
4114689

2x
370926

2x
403226

1x
4531412

1x
4538456

1x
4248831

6x
4639695

4x
4159335

8x
4155558

4x
4107082

30x
4121715

2x
4526982

2x
4188143

2x
370226

2x
370326

2x
374726

1x
4515340

1x
4299388

1x
4243819

2x
4119589

2x
4140801

1x
370626

1x
370826

8x
3005740

1x
4278412

2x
4626724

2x
4650183

10x
4544720

3x
3005741

7x
4163917

1x
4293877

16x
4567332

4x
6040341

1x
4153826

7x
4121742

4x
4251969

17x
4177932

13x
4160593

3x
4180512

3x
4180540

1x
6023278

2x
6023288

1x
6022375

2x
6022056

2x
6021593

1x
6029581

1x
6004919

8x
4650976

1x
4654448



Customer Service
Kundenservice
Service Consommateurs
Servicio Al Consumidor
LEGO.com/service or dial

: 00800 5346 5555
: 1-800-422-5346



GALAXY SQUAD



70700



70701



70702



70703



70704



LEGO



GALAXY
SQUAD



LEGO.com/galaxysquad



WIN!

Go to www.LEGOsurvey.com/product to fill out a survey for a chance to win a cool LEGO® Product.

No purchase necessary.

Open to all residents where not prohibited.

 LEGO.com



www.LEGOsurvey.com/product

GEWINNE!

Nimm an der Umfrage auf www.LEGOsurvey.com/product teil und hab die Chance ein cooles LEGO® Produkt zu gewinnen!

Die Teilnahme am Gewinnspiel führt zu keinerlei Kaufverpflichtungen. Teilnahme in allen nicht ausgeschlossenen Ländern möglich.

WIN!

Ga naar www.LEGOsurvey.com/product, vul een enquêteformulier in en maak kans op een cool LEGO® product.

Geen aankoopverplichting. Iedereen mag deelnemen, uitgezonderd ingezetenden van landen waar een enquêteverbod geldt.

GAGNE!

Visite www.LEGOsurvey.com/product pour répondre à un questionnaire et avoir une chance de gagner un produit LEGO® très cool!

Aucune obligation d'achat. Ouvert à tous les résidents des pays autorisés.

当てよう!

www.LEGOsurvey.com/product にアクセスして、アンケートにご記入ください。当選者にはレゴ製品を差し上げます。

お買い上げの必要はありません。禁止されていない限り、すべての皆様にご利用いただけます。